

# Stompa® Classic Chest 3 Drawers

Assembly Instructions - Please keep for future reference

STK787901/02

## Dimensions

Width - 74,0 cm  
Depth - 40,0 cm  
Height - 71,5 cm

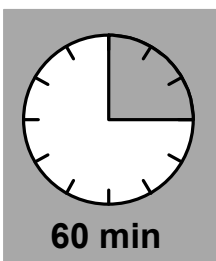

60 min

- |      |                                      |      |                                |
|------|--------------------------------------|------|--------------------------------|
| (D)  | <i>Montageanleitung instructions</i> | (GB) | <i>Assembly instructions</i>   |
| (NL) | <i>Handleiding voor de montage</i>   | (PL) | <i>Instrukcja montażu</i>      |
| (TR) | <i>Montaj talimatı</i>               | (RU) | <i>Инструкция по монтажу</i>   |
| (FR) | <i>Notice de montage</i>             | (IT) | <i>Istruzioni di montaggio</i> |
| (CS) | <i>Montážní návod</i>                | (SK) | <i>Návod na montáž</i>         |
| (HU) | <i>Szerelési útmutató</i>            | (RO) | <i>Instrucțiuni de montaj</i>  |

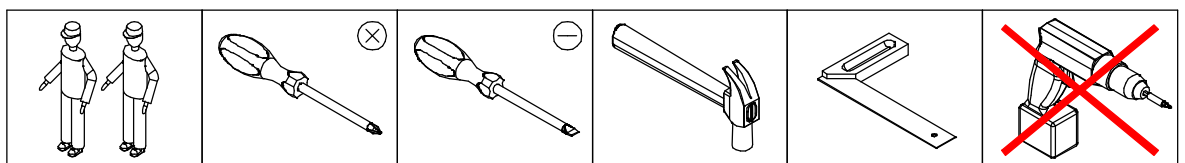

Important – Please read these instructions fully before starting assembly

If you need help or have damaged or missing parts, call the Customer Helpline: **0330 1241100**  
E-mail: [enquiries@bensonsforbeds.co.uk](mailto:enquiries@bensonsforbeds.co.uk)



# Instructions for use

**IMPORTANT, READ CAREFULLY- RETAIN FOR FUTURE REFERENCE**

**WARNING:** This product is suitable for children above the age of 3 years old

## Before starting assembly:

\*Do not use this item if any structural part is broken or missing.

\*Check you have all the components and tools listed.

\*Remove all fittings from the plastic bags and separate them into their groups.

\*Keep children and animals from the work area, small parts could choke if swallowed.

\*Make sure you have enough space to lay out the parts before starting.

\*Assemble the items as close to its final position (in the same room) as possible.

\*Assemble on the soft level surface to avoid damaging the unit or your floor.

\*This furniture meets the european standard certification BS 4875-7:2006, FRQG C001:2008 & FRQG C004:2008



We do not recommend the use of power drills/drivers for inserting screws, as this could damage the unit. Only use hand screwdrivers.

\*Dispose of all packaging carefully and responsibly.

\*Assembly should be carried out by competent adult only.

## Care and maintenance:

\* Only clean using a damp cloth and mild detergent, do not use bleach or abrasive cleaners.

\*Regularly check all fastenings to ensure that they properly tightened.

\*Our furniture will endure most temperatures in the home but it is best to avoid placing furniture next to the heat sources such as radiators or fires. Be particularly careful with solid wood as the lack of humidity caused by central heating can cause damage such as warping.

### Wall Fixing (if required)

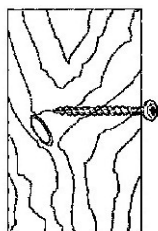

Wood

If fixing to wood make sure that it isn't chipboard as screws can easily pull away.

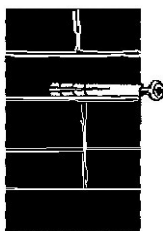

Brick or Masonary

Use an appropriate wall plug provided you are sure your wall is sound.

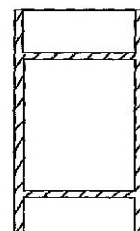





Cavity wall

Special toggle wall plugs are needed. Seek expert advice.

# Components - Fittings

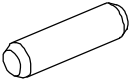
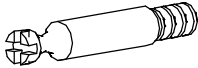
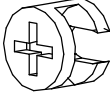
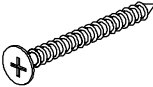
Please check you have all the fittings listed below

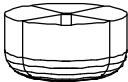
Note: The quantities below are the correct amount to complete the assembly. In some cases more fittings may be supplied than are required.

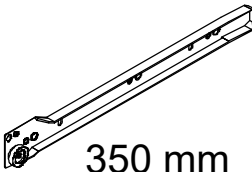
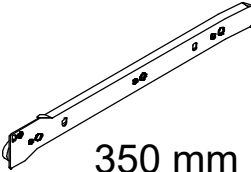
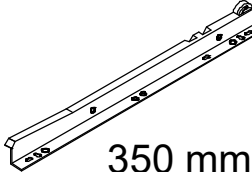
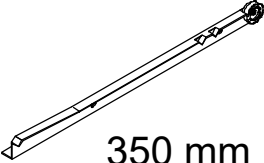
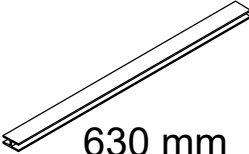
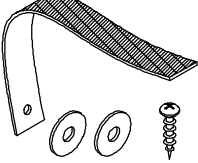
<b>A</b>  8x30      x32	<b>B</b>  x36	<b>C</b>  D15      x36
<b>D</b>  4,0x30      x4	<b>E</b>  3,0x12      x12	<b>F</b>  x8
<b>G</b>  x4	<b>H</b>  2,1x20      x30	<b>I</b>  6,3x9      x18
<b>J</b>  350 mm      x3	<b>K</b>  350 mm      x3	<b>L</b>  350 mm      x3
<b>M</b>  350 mm      x3	<b>N</b>  630 mm      x1	<b>O</b>  x1

## Tools required

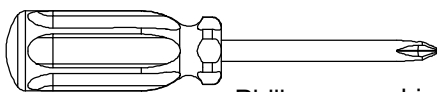

Philips screwdriver (medium)

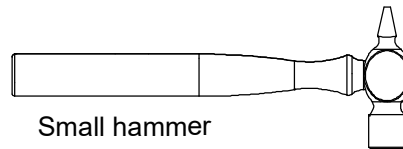

Small hammer

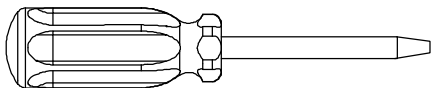

Flathead screwdriver (medium)

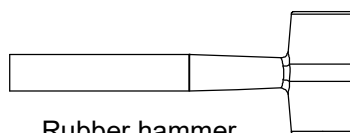

Rubber hammer

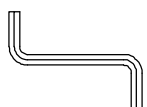

Allen key (incl)

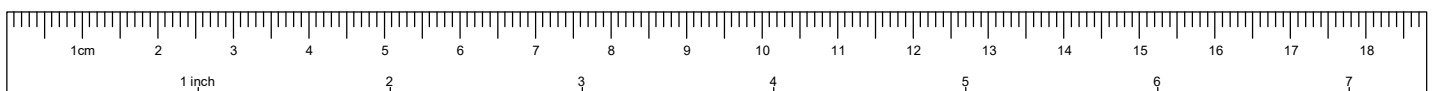

Rulers - Use this ruler to help correctly identify the screws

# Components - Panels

Please check you have all the panels listed below

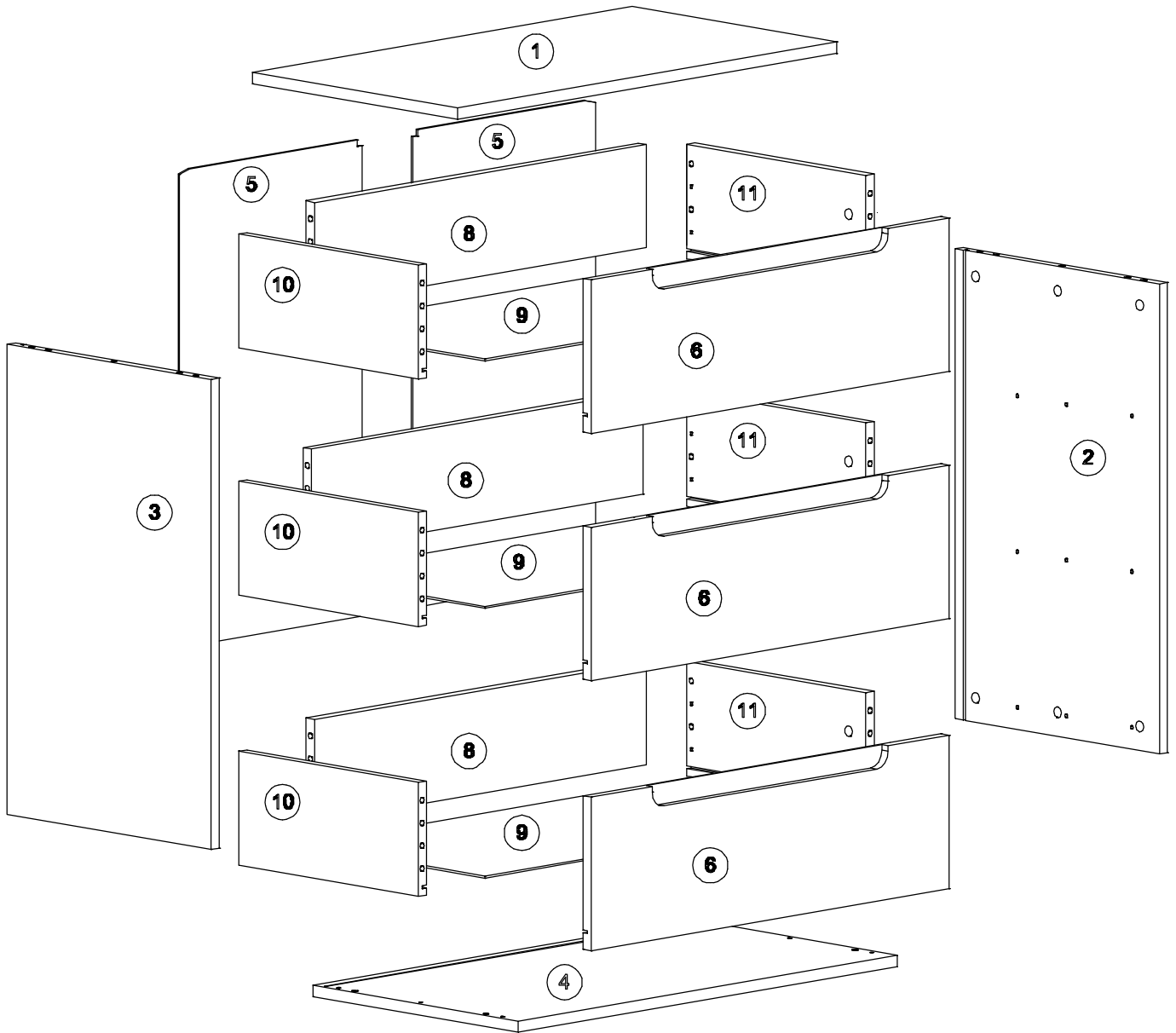

1

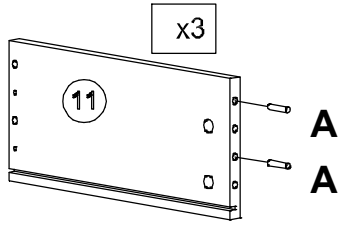
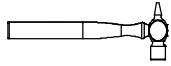

x3

A  
A

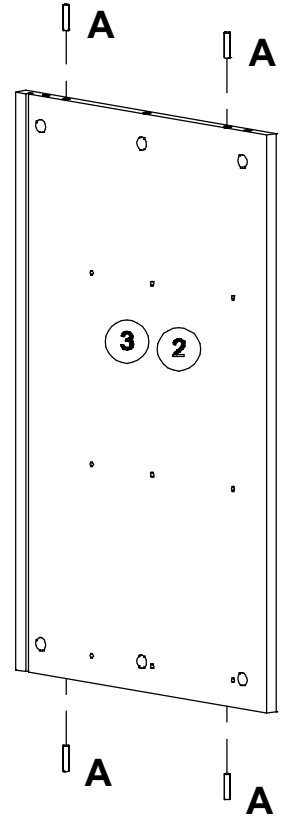
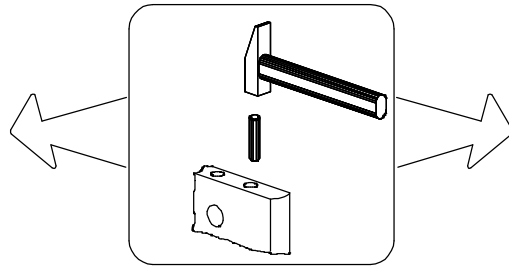

3 2

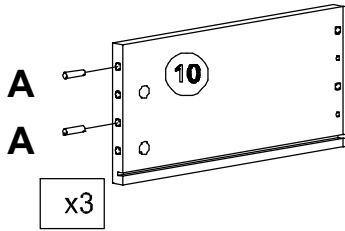

A  
A

x3

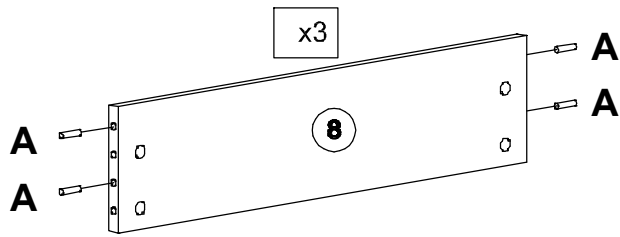

A  
A

x3

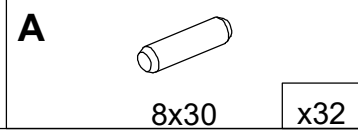

A

8x30

x32

2

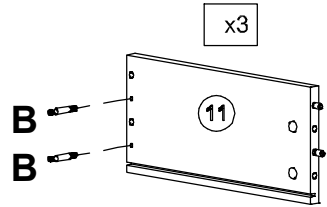
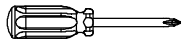

x3

B  
B

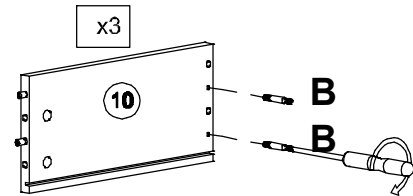

x3

B  
B

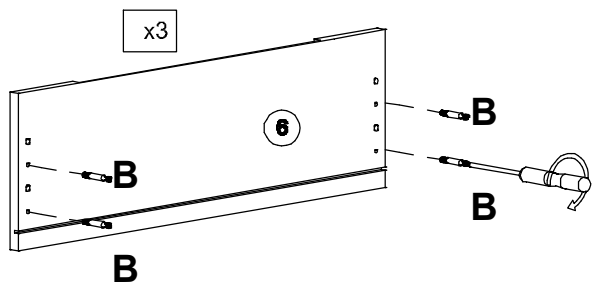

x3

B  
B  
B

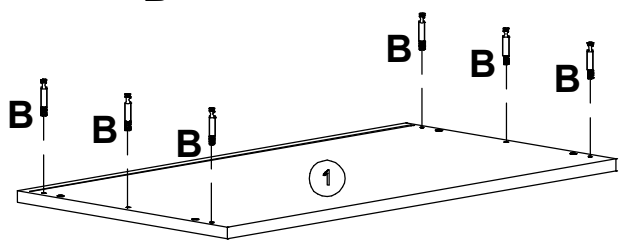

B  
B  
B

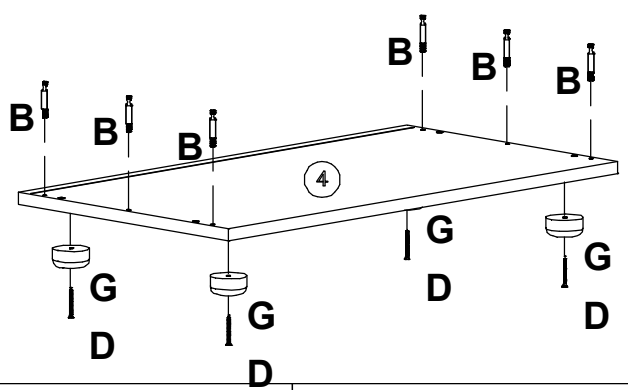

B  
B  
B

B  
B  
B

G  
D  
G  
D

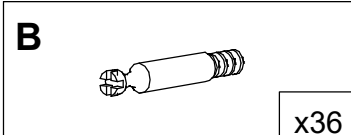

B

x36

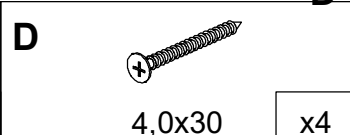

D

4,0x30

x4

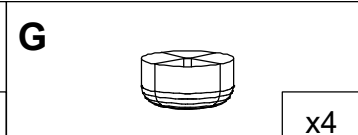

G

x4

3

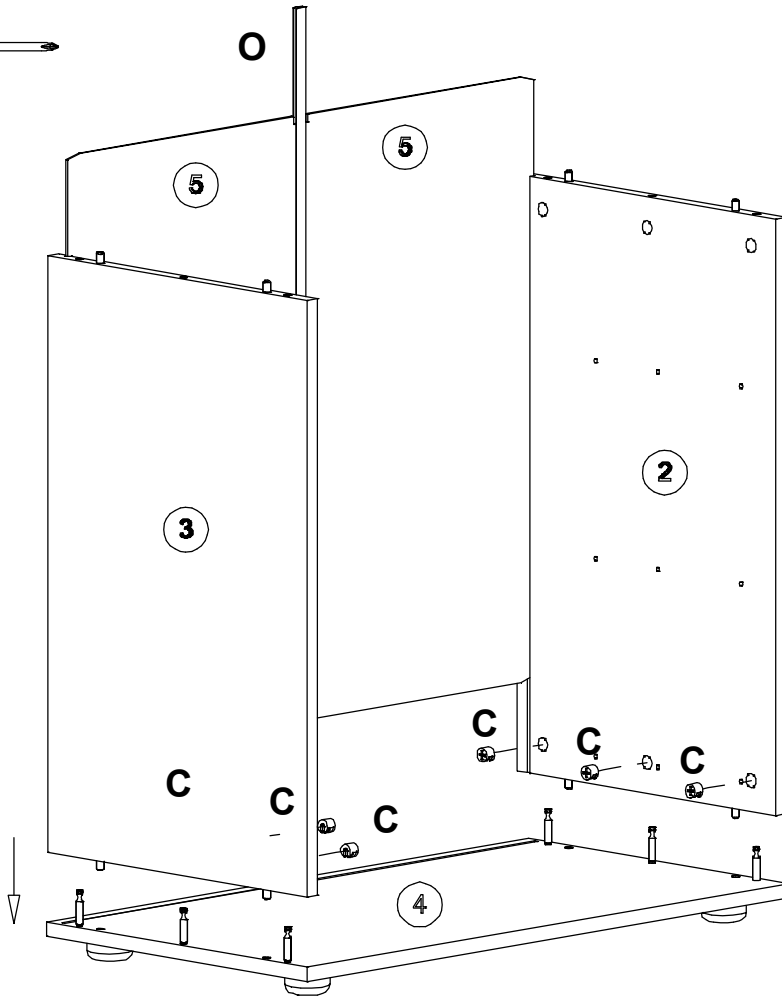
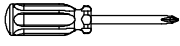

C		D15	x6
O		630 mm	x1

4

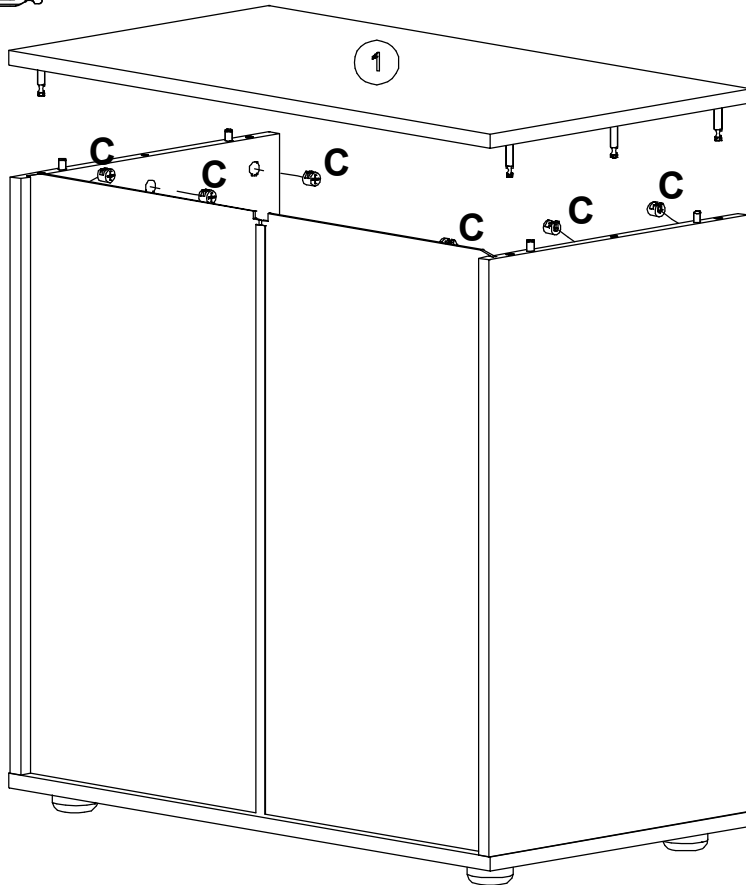
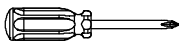

C		D15	x6
---	--	-----	----

5

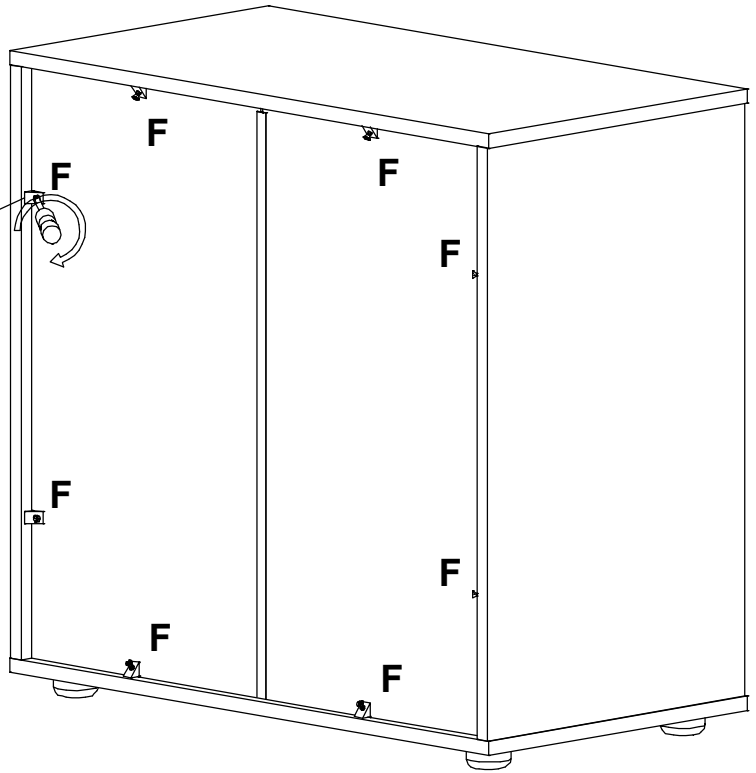
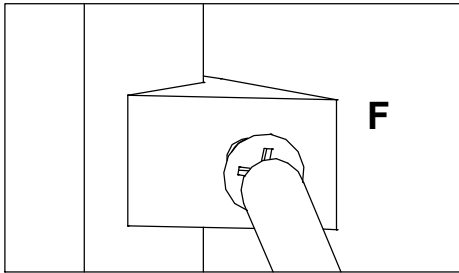
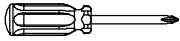

F



x8

6

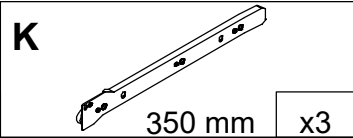
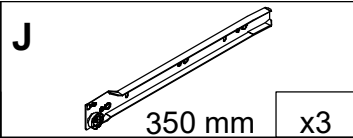
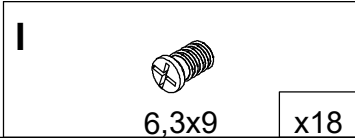
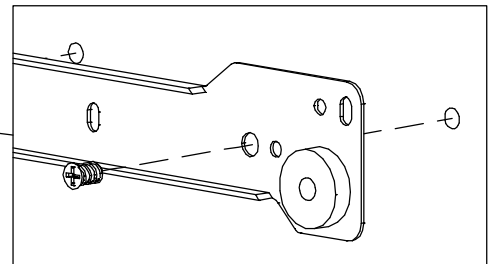
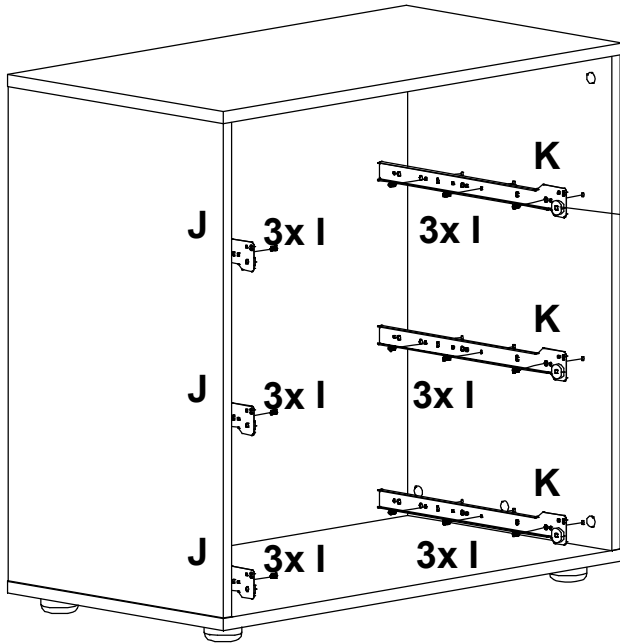
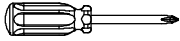

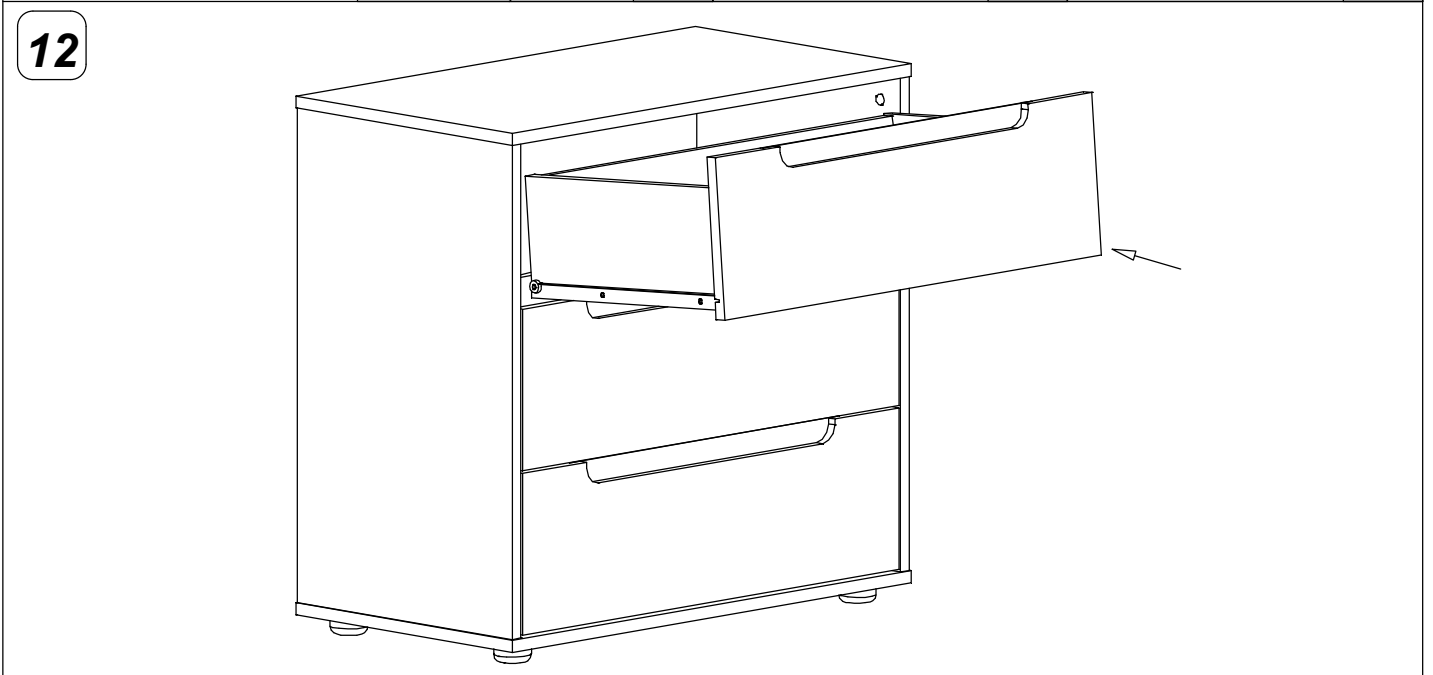
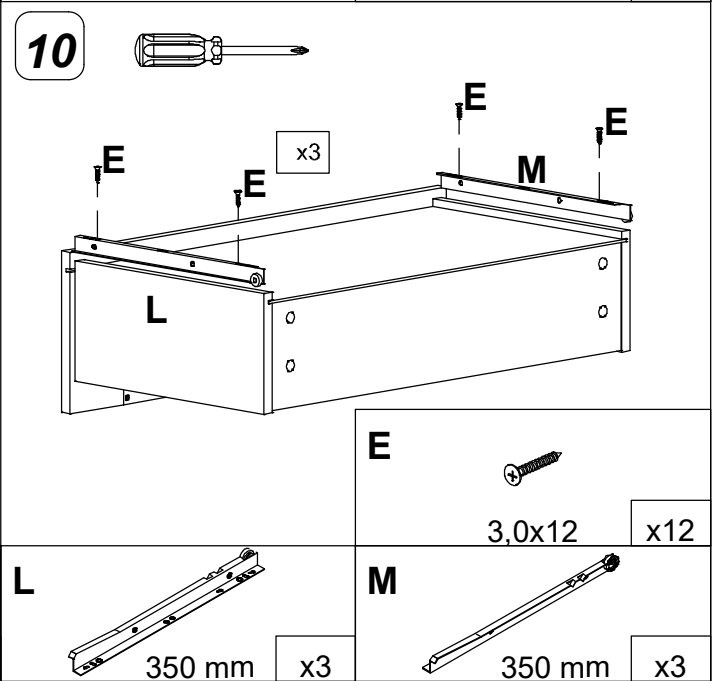
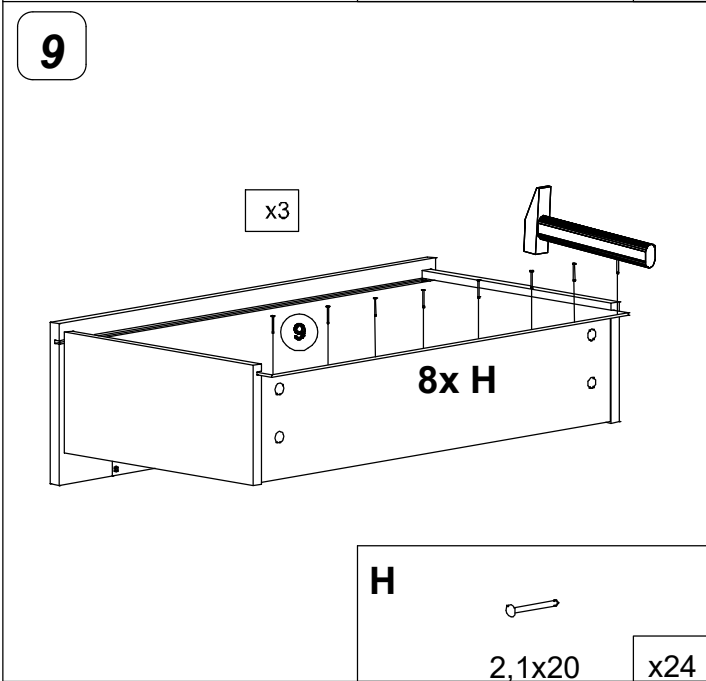
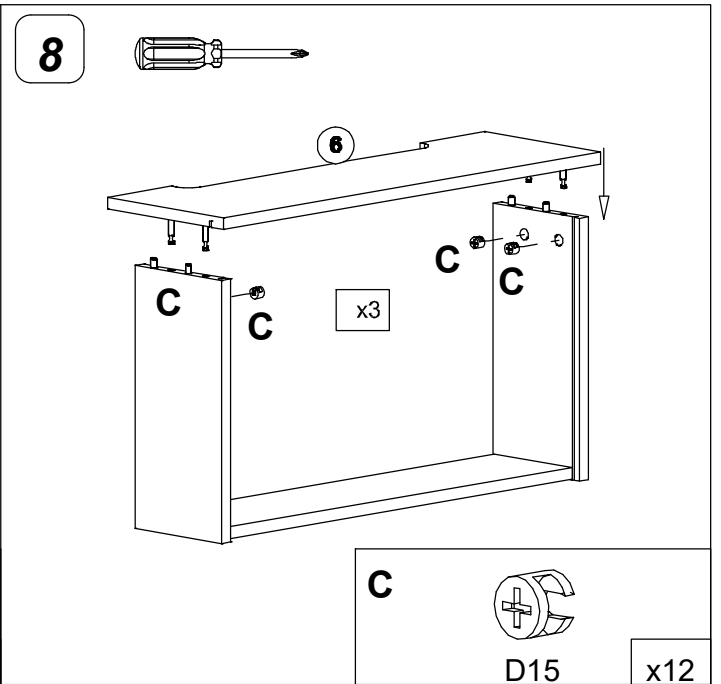
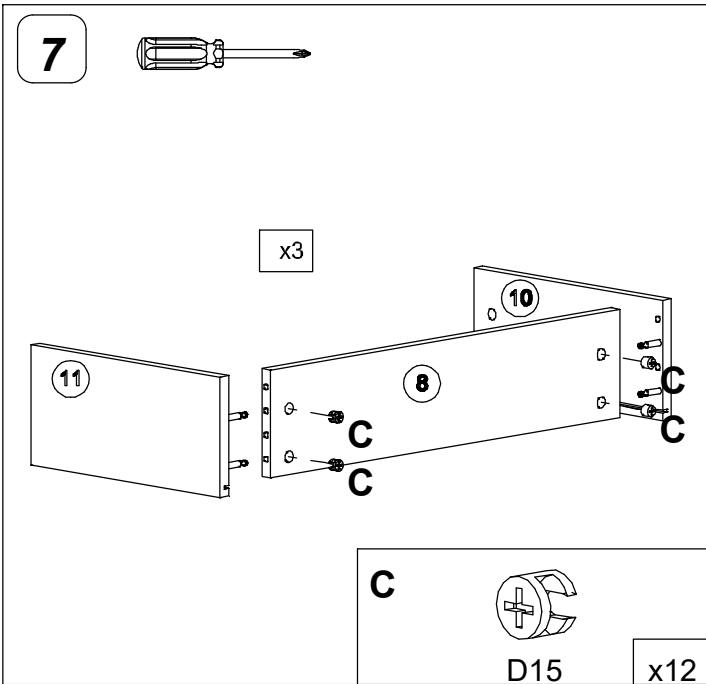



13

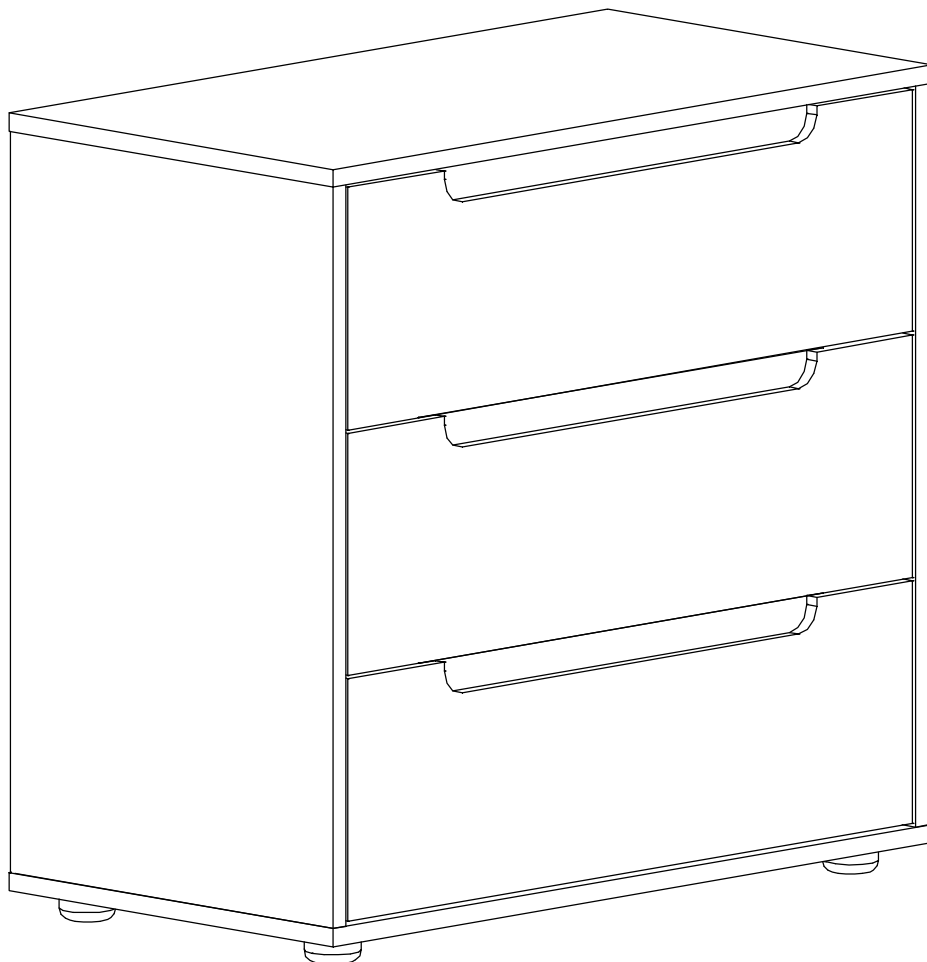

## ATTENTION!

**ATTACHING TO WALL.  
IF YOU ARE STACKING UNITS ON TOP  
OF EACH OTHER IT IS ESSENTIAL FOR  
YOUR CHILDREN'S SAFETY THAT YOU  
FOLLOW THE INSTRUCTIONS IN THE  
BAG WITH THE SAFETY STRAP.**

