

# Stompa® Classic Pullout Desk

Assembly Instructions - Please keep for future reference

STK787901/02

## Dimensions

Width - 75,2 cm

Depth - 91,5 cm

Height - 73,0 cm

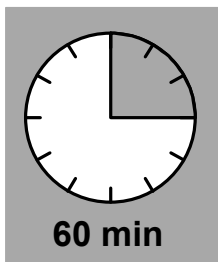
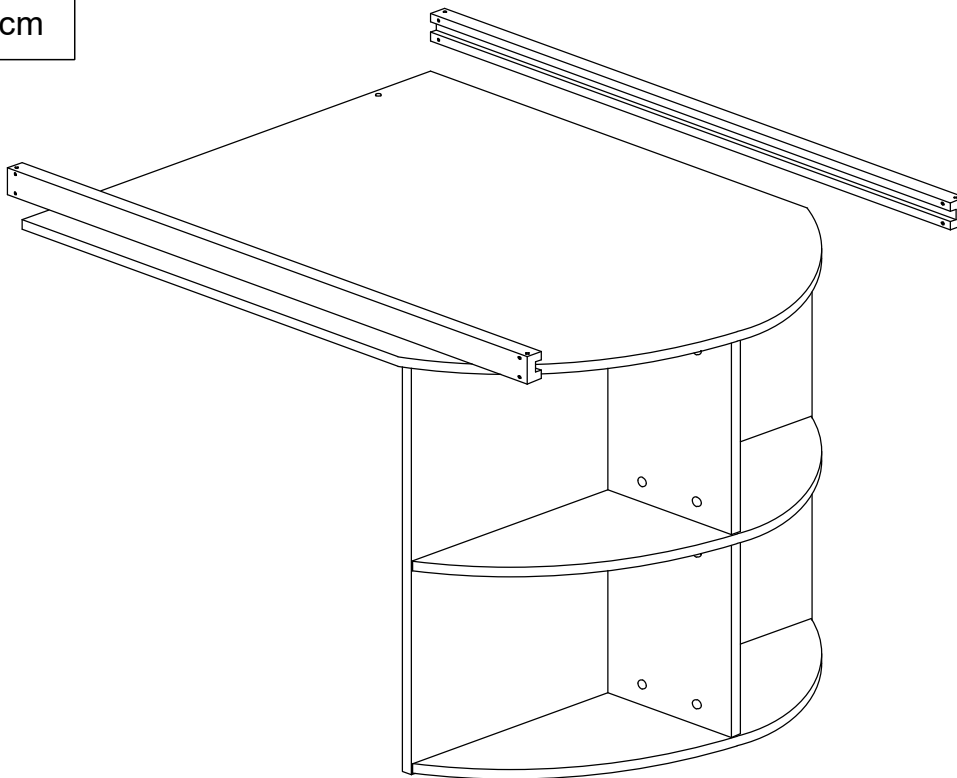

- |  |                                     |
|--|-------------------------------------|
| (D) <i>Montageanleitung instructions</i> | (GB) <i>Assembly instructions</i>   |
| (NL) <i>Handleiding voor de montage</i>  | (PL) <i>Instrukcja montażu</i>      |
| (TR) <i>Montaj talimatı</i>              | (RU) <i>Инструкция по монтажу</i>   |
| (FR) <i>Notice de montage</i>            | (IT) <i>Istruzioni di montaggio</i> |
| (CS) <i>Montážní návod</i>               | (SK) <i>Návod na montáž</i>         |
| (HU) <i>Szerelési útmutató</i>           | (RO) <i>Instrucțiuni de montaj</i>  |

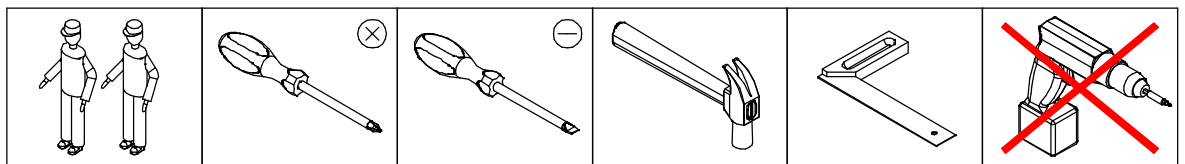

Important – Please read these instructions fully before starting assembly

If you need help or have damaged or missing parts, call the Customer Helpline: **0330 1241100**  
E-mail: [enquiries@bensonsforbeds.co.uk](mailto:enquiries@bensonsforbeds.co.uk)



# Instructions for use

**IMPORTANT, READ CAREFULLY- RETAIN FOR FUTURE REFERENCE**

**WARNING:** This product is suitable for children above the age of 3 years old

## Before starting assembly:

\*Do not use this item if any structural part is broken or missing.

\*Check you have all the components and tools listed.

\*Remove all fittings from the plastic bags and separate them into their groups.

\*Keep children and animals from the work area, small parts could choke if swallowed.

\*Make sure you have enough space to lay out the parts before starting.

\*Assemble the items as close to its final position (in the same room) as possible.

\*Assemble on the soft level surface to avoid damaging the unit or your floor.

\*This furniture meets the european standard certification BS 4875-7:2006, FRQG C001:2008 & FRQG C004:2008



We do not recommend the use of power drills/drivers for inserting screws, as this could damage the unit. Only use hand screwdrivers.

\*Dispose of all packaging carefully and responsibly.

\*Assembly should be carried out by competent adult only.

## Care and maintenance:

\* Only clean using a damp cloth and mild detergent, do not use bleach or abrasive cleaners.

\*Regularly check all fastenings to ensure that they properly tightened.

\*Our furniture will endure most temperatures in the home but it is best to avoid placing furniture next to the heat sources such as radiators or fires. Be particularly careful with solid wood as the lack of humidity caused by central heating can cause damage such as warping.

# Components - Fittings

Please check you have all the fittings listed below

Note: The quantities below are the correct amount to complete the assembly. In some cases more fittings may be supplied than are required.

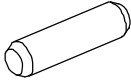
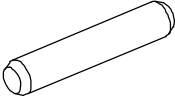
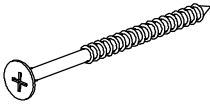
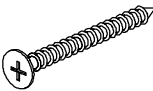
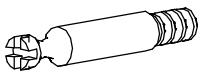
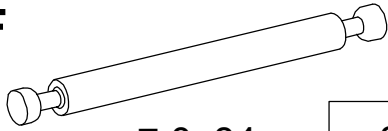
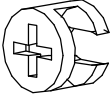
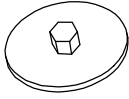
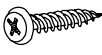
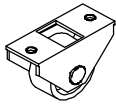
<b>A</b>  8x30      x18	<b>B</b>  8x50      x2	<b>C</b>  4,0x60      x4
<b>D</b>  3,5x45      x4	<b>E</b>  7,0x45      x16	<b>F</b>  7,0x84      x2
<b>G</b>  D15x12      x20	<b>H</b>  D17      x20	<b>I</b>  3,5x16      x4
<b>J</b>  x2		

## Tools required

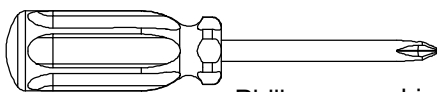

Philips screwdriver (medium)

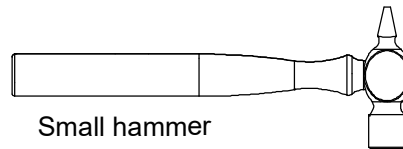

Small hammer

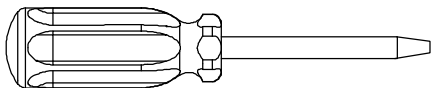

Flathead screwdriver (medium)

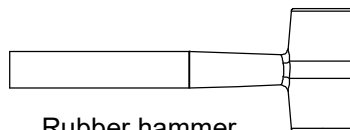

Rubber hammer

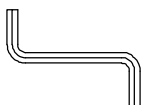

Allen key (incl)

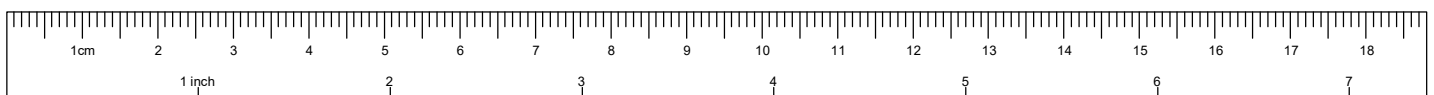

Rulers - Use this ruler to help correctly identify the screws

# Components - Panels

Please check you have all the panels listed below

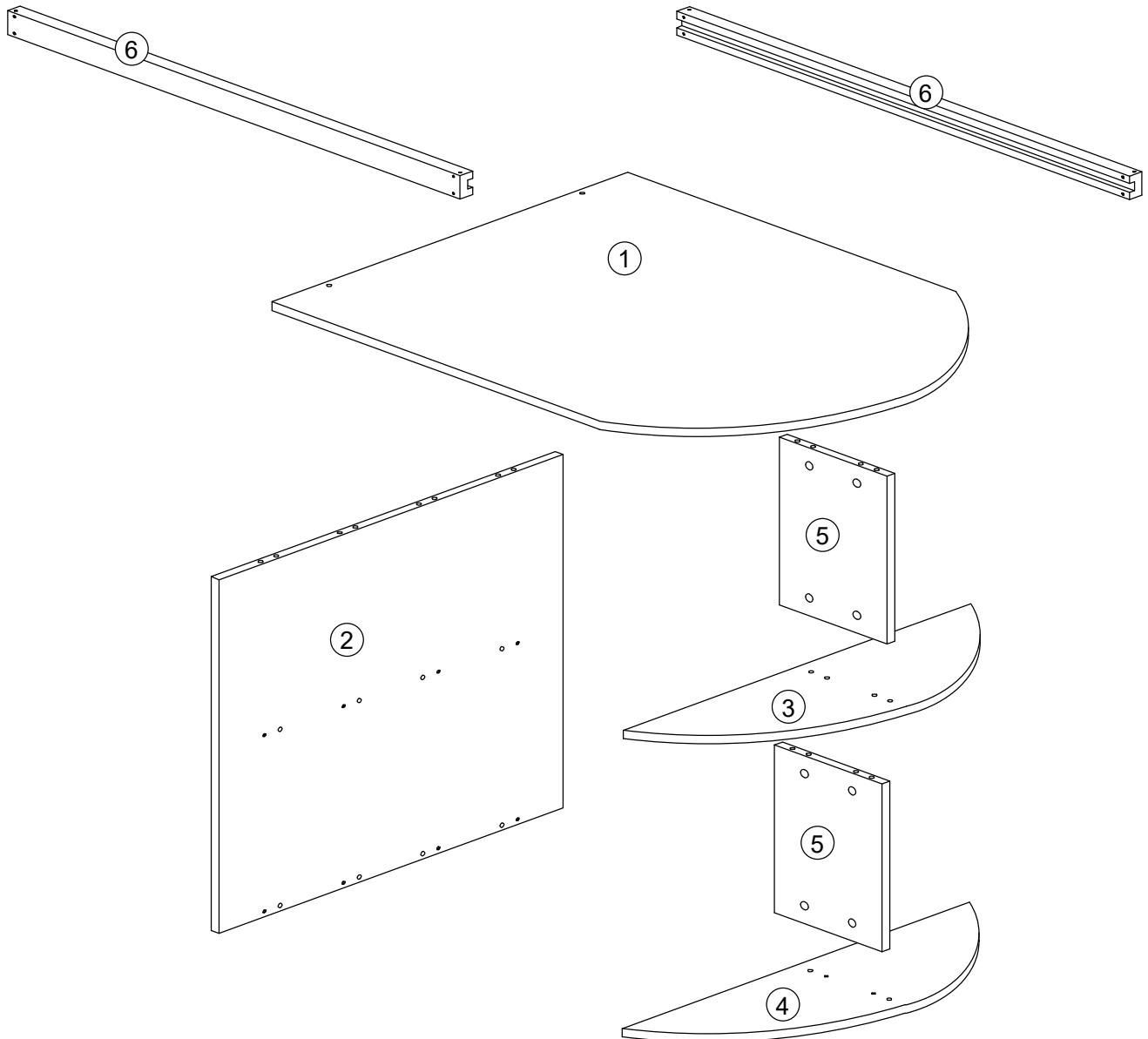

NO.	PART LIST	QTY	DIMENSION	BOX NUMBER
1.	Top	1	900 x 720 x 16 mm	1 of 3
2.	Back panel	1	672 x 696 x 16 mm	1 of 3
3.	Shelf	1	962 x 220 x 16 mm	1 of 3
4.	Base	1	962 x 220 x 16 mm	1 of 3
5.	Partition panel	2	319 x 217 x 16 mm	2 of 3
6.	Support rail	2	915 x 45 x 25 mm	2 of 3
7.	Fittings	1		1 of 1



Achtung • Attention • Attenzione • Opgelet • Uwaga • Pozor • Figyelem • Atenție •  
Dikkat • Внимание

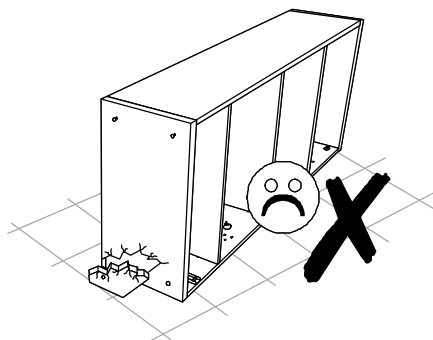
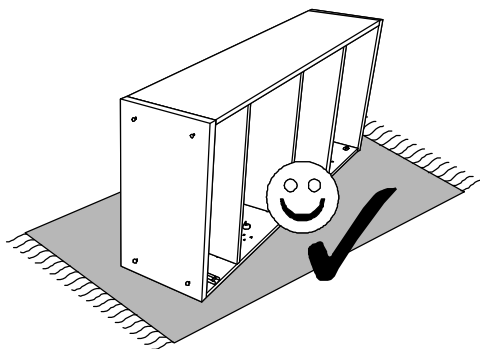

1

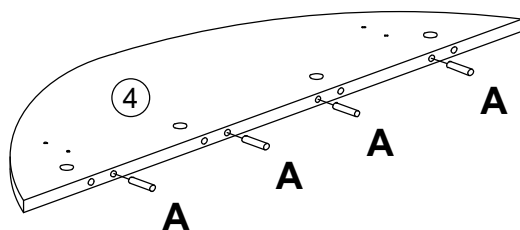
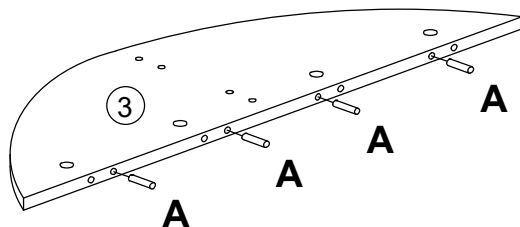
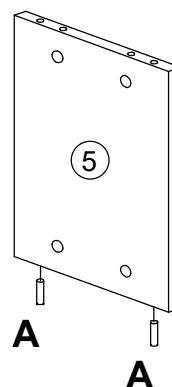
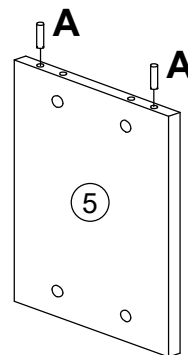
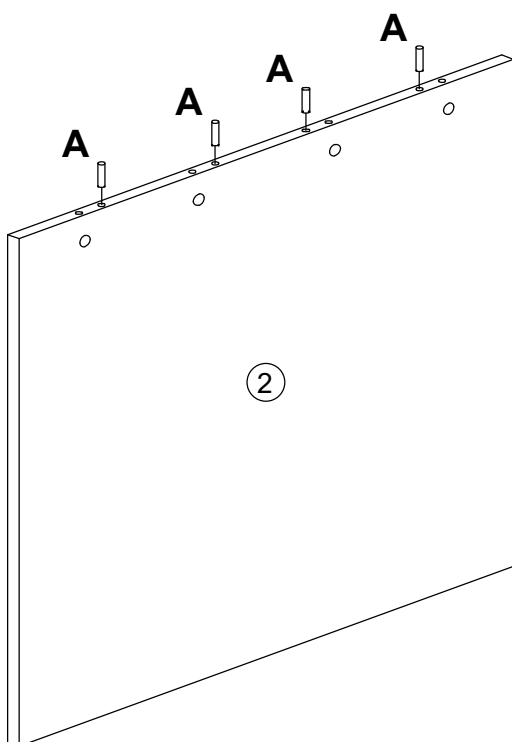
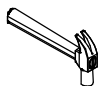

A

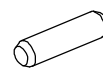

8x30

x16

2

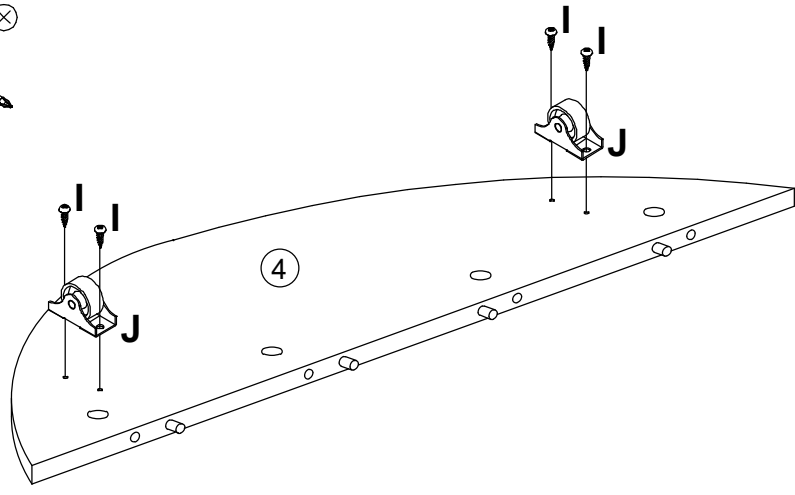
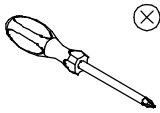

I		
	3,5x16	x4

J		
		x2

3

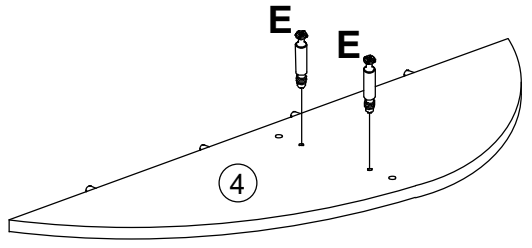
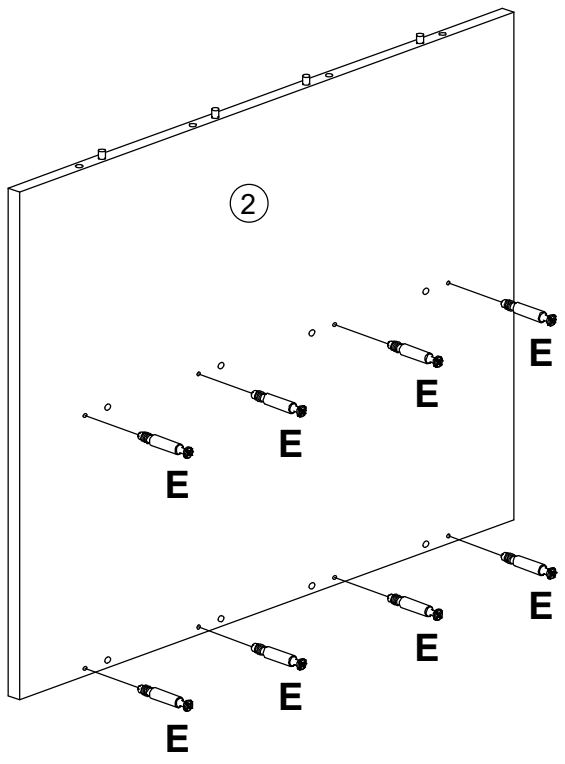
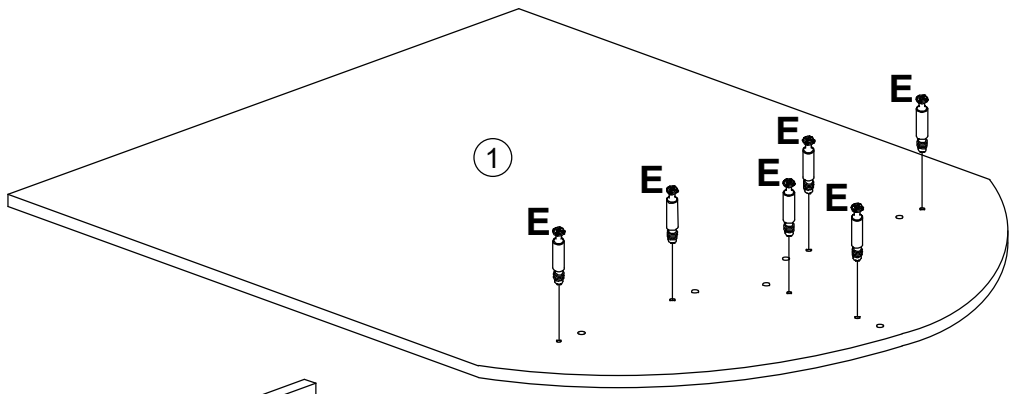
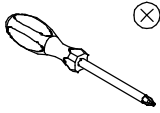

E		
	7,0x45	x16

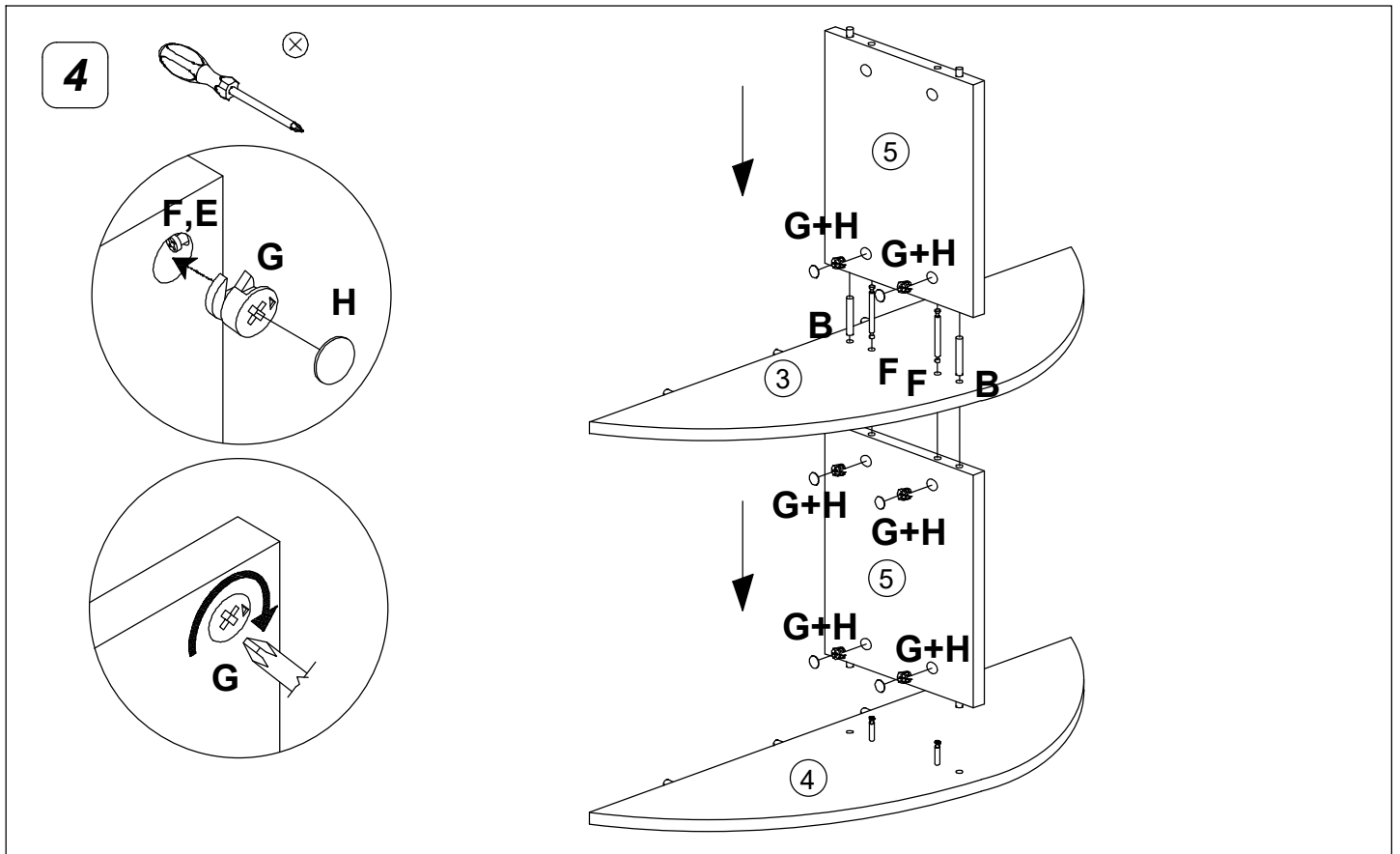

<p><b>B</b></p> <p>8x50    x2</p>	<p><b>F</b></p> <p>7,0x84    x2</p>	<p><b>G</b></p> <p>D15x12    x6</p>	<p><b>H</b></p> <p>D17    x6</p>
-----------------------------------	-------------------------------------	-------------------------------------	----------------------------------

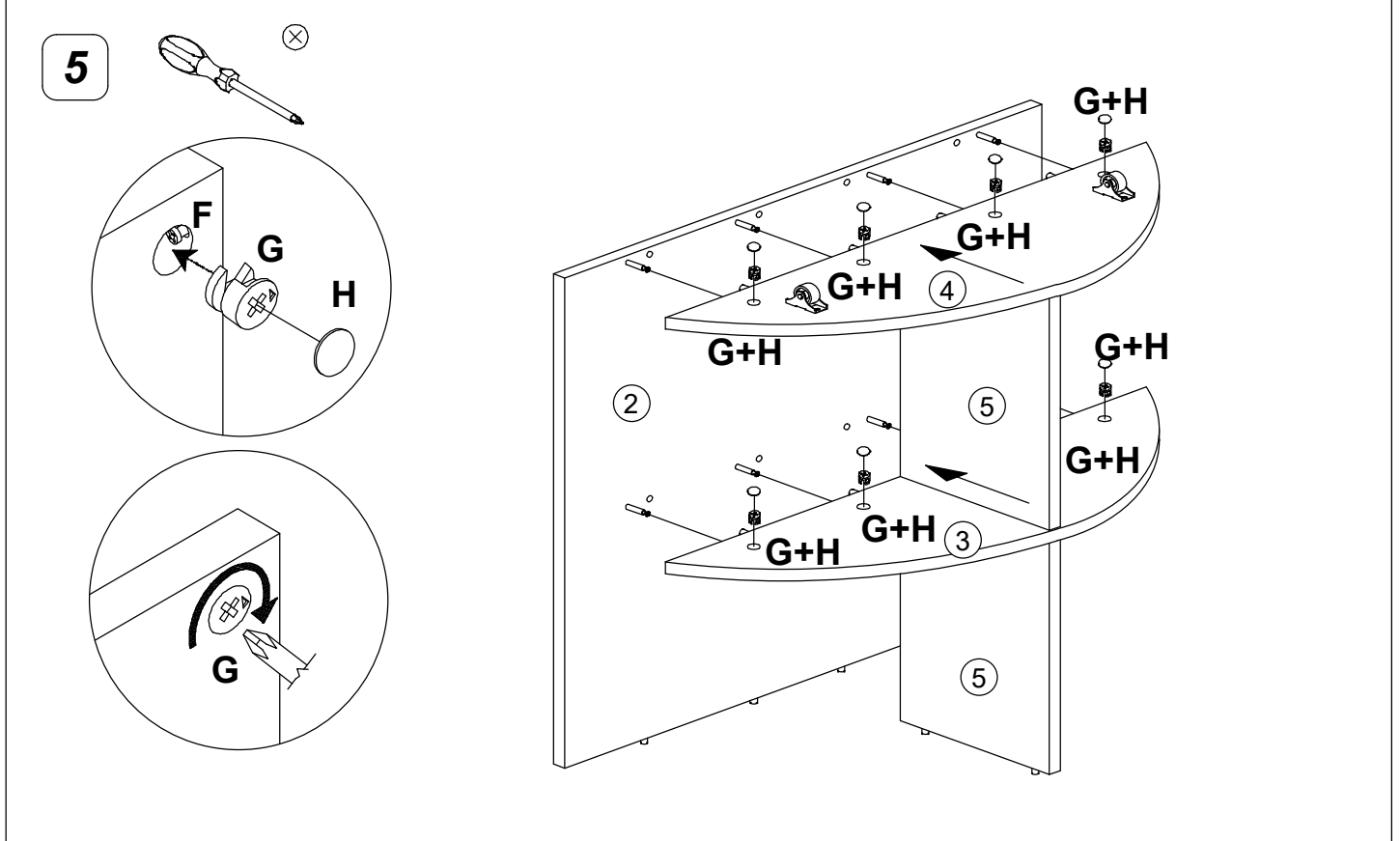

<p><b>G</b></p> <p>D15x12    x8</p>	<p><b>H</b></p> <p>D17    x8</p>
-------------------------------------	----------------------------------

6

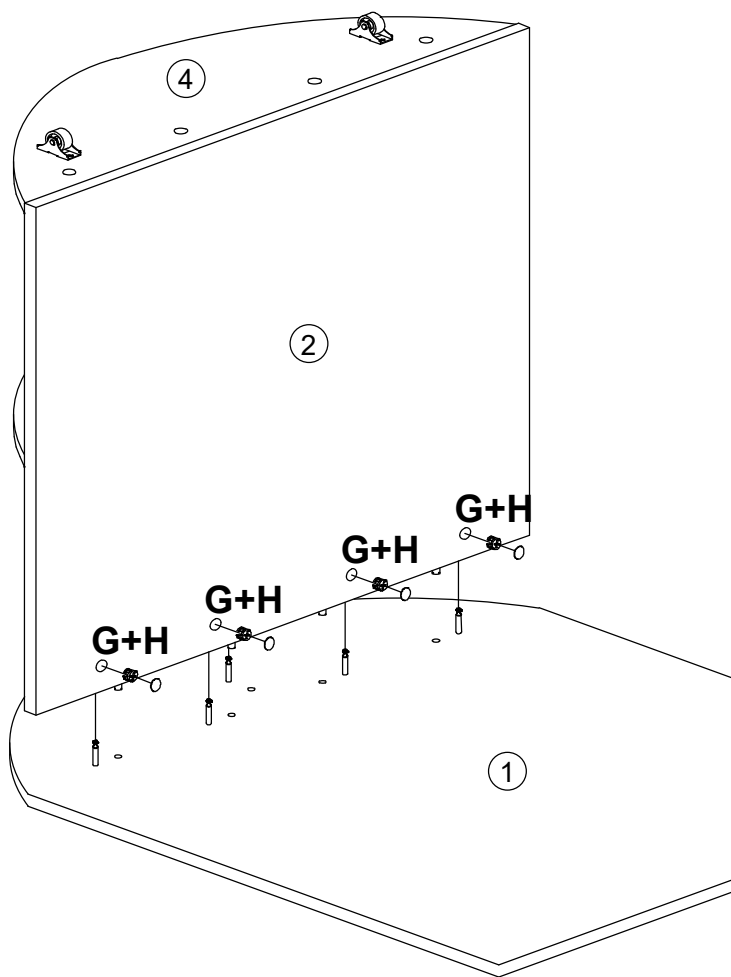
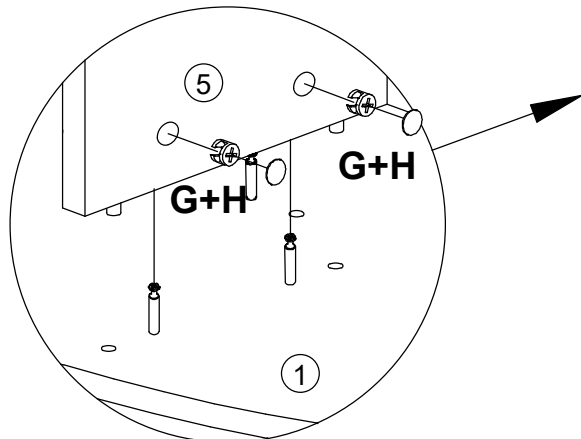
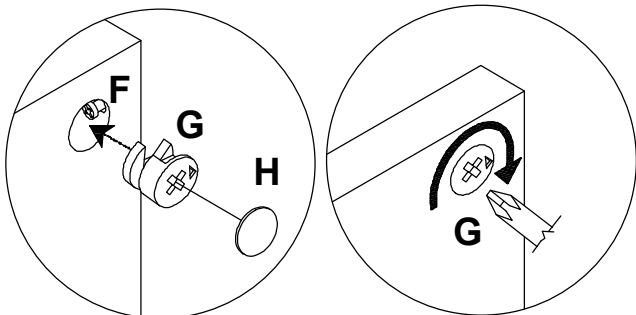
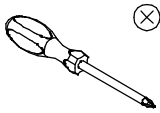

<b>G</b>		
	D15x12	x6

<b>H</b>		
	D17	x6

7

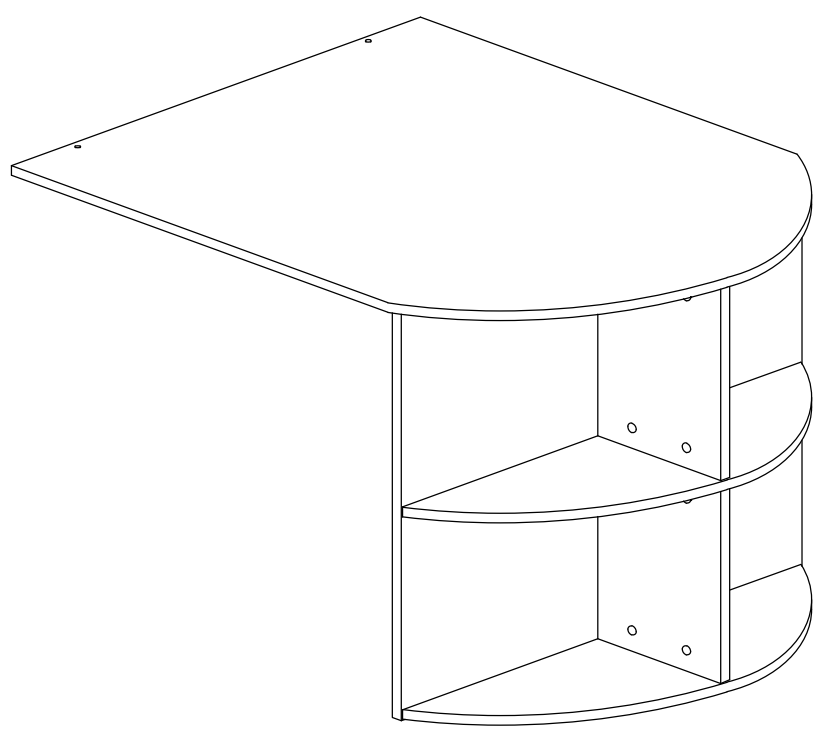



8

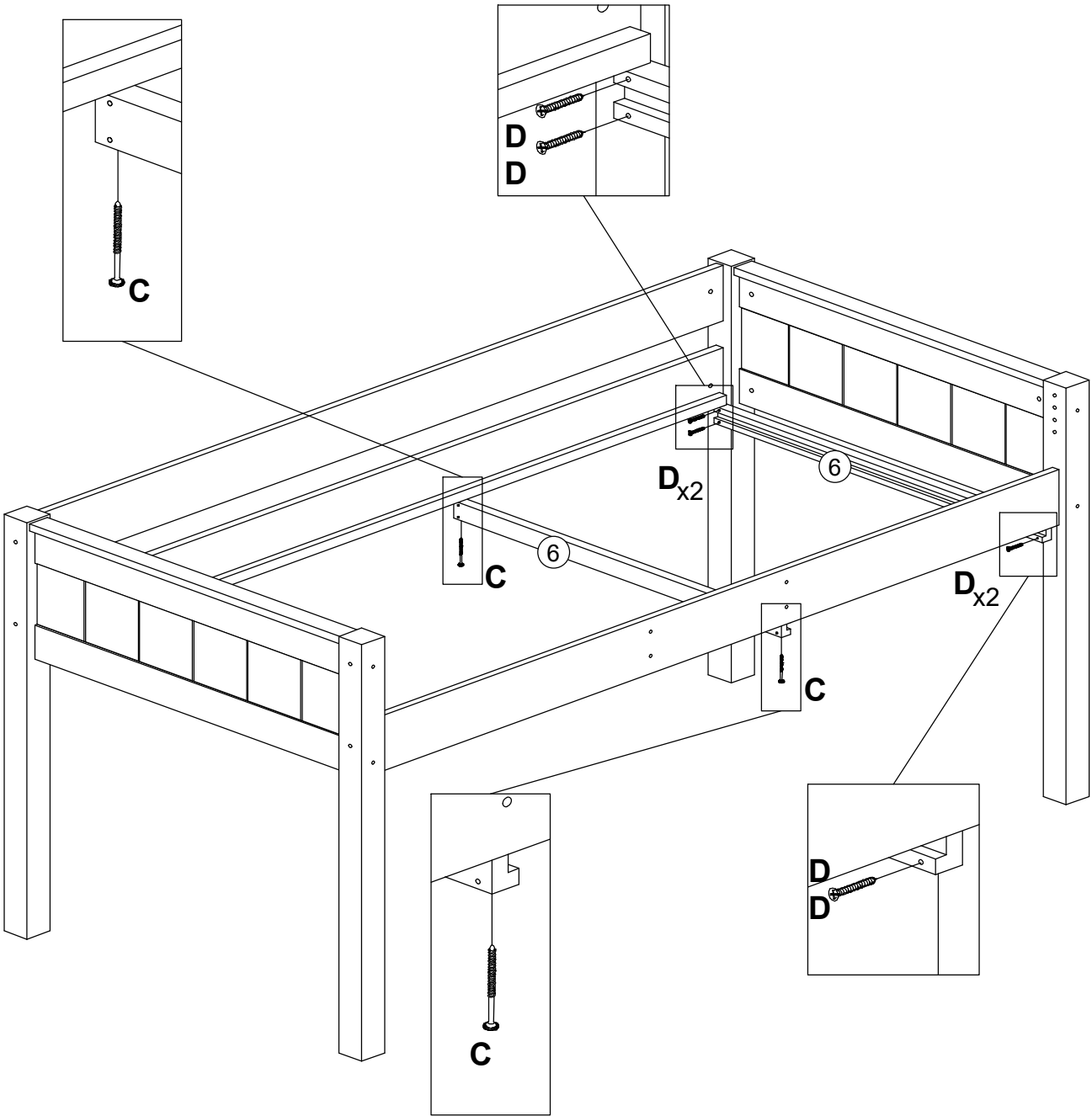
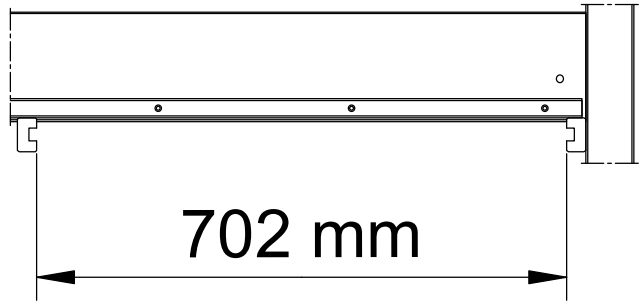
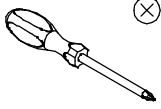

<b>C</b>		<b>D</b>	
	4,0x60		3,5x45
	x2		x4

9

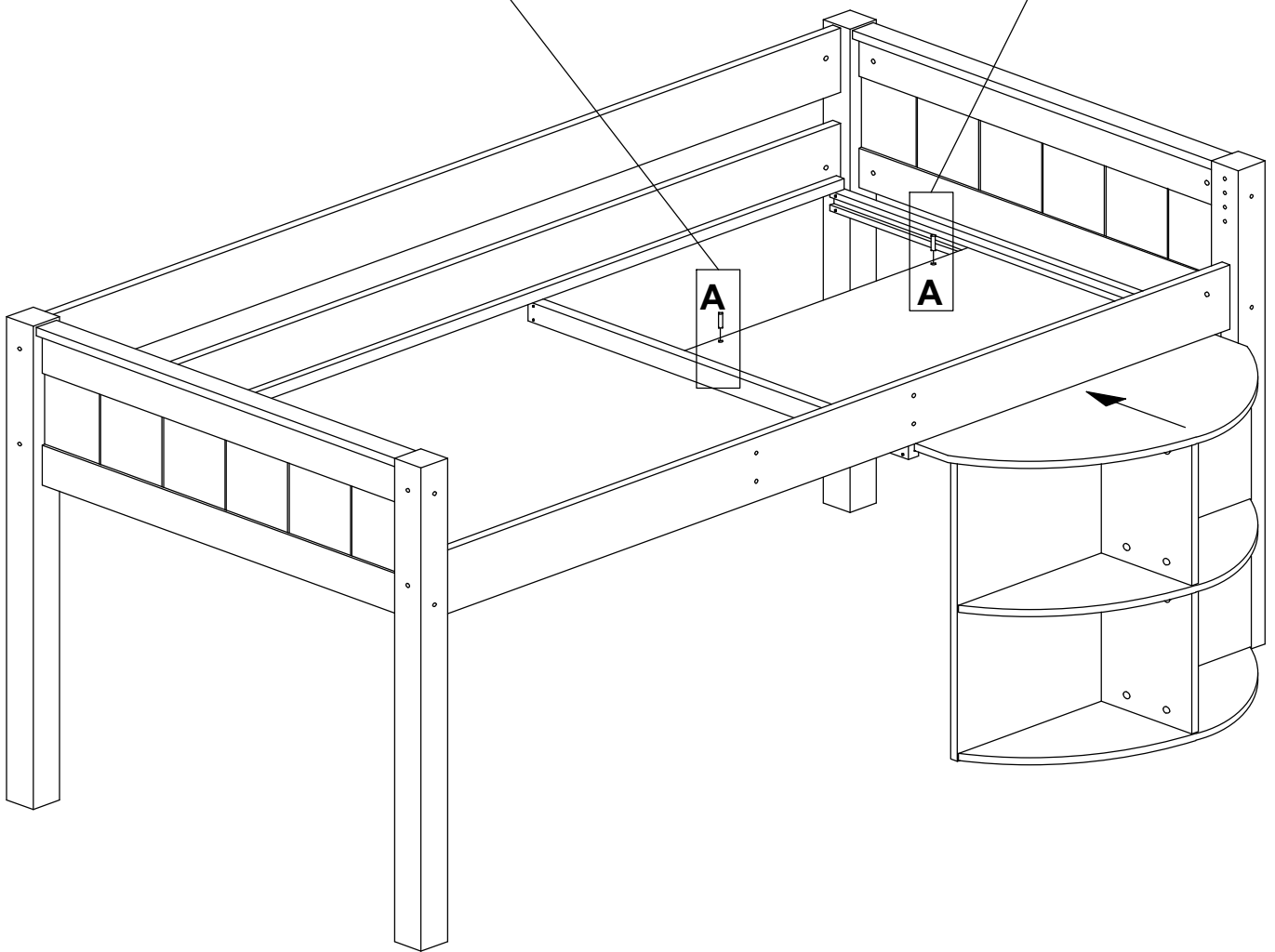
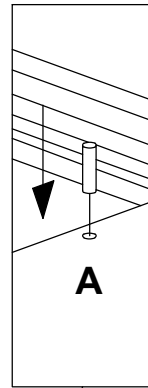
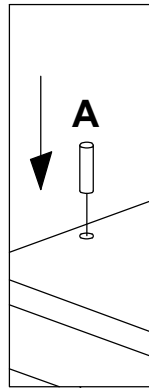
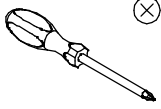

**A**

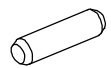

8x30

x2