

Minimum Two
Persons Assembly



Durham 135CM Bed Frame

STK727503/STK727504

Assembly instructions
Please keep these instructions for future reference.

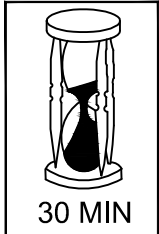

Approximate
Assembly Time

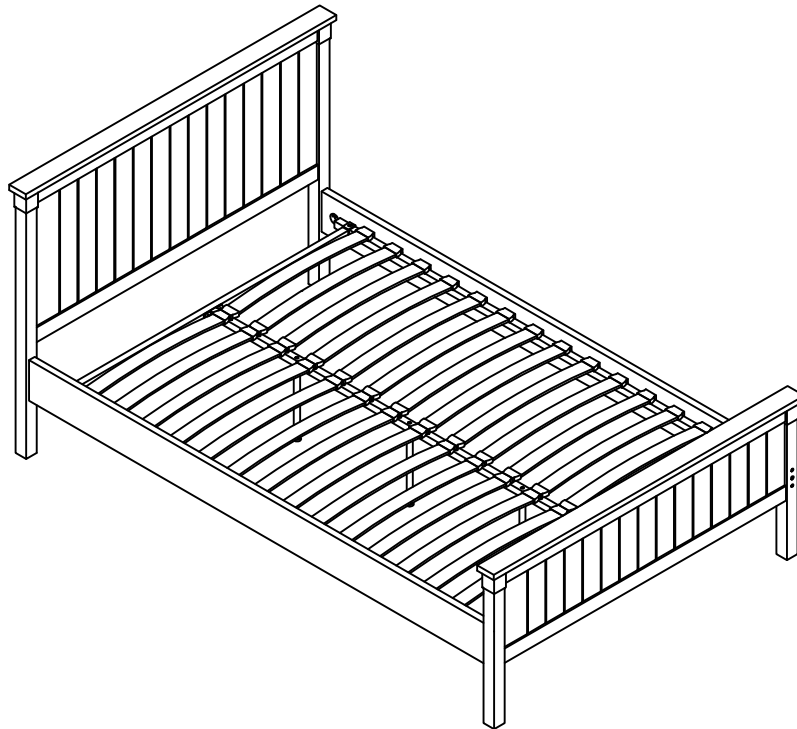

Regrettably self-assembly items cannot be returned once assembly is part or fully completed unless the items are found to be faulty. Should you need to return the unassembled product, please repack in its original packaging.

Important information

- We suggest you spend a short time reading through this leaflet and then follow the simple step-by-step instructions.
- Carefully check that you have all the parts before beginning assembly.
- Keep fittings out of children's reach and keep children well away from construction area.
- We suggest you retain these instructions for future reference.
- In the unusual event of an issue with your product would you please quote the batch I.D. number situated on the main parts of the frame (Head End- Foot End- side Rails).





Product information

- Product finished in either white or grey painted finish.
- Conforms to BS EN1725 standard .
- Posture slats.



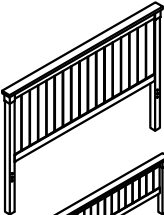
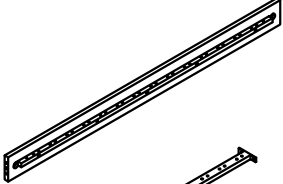
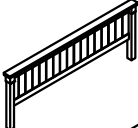
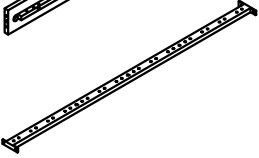
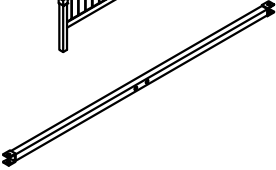









Care instructions

- Avoid exposing the furniture to excessive heat or direct sunlight as this can cause cracking and deterioration of the color.
- Periodically check & re-tighten any fastener.
- Periodically dust lightly with a clean soft cloth.
- Do not use silicone based furniture polish.
- Any spills should be removed immediately with a damp cloth.
- TAKE CARE WHEN MOVING THE FURNITURE AND NEVER DRAG THE PIECES ACROSS THE FLOOR, AS THIS WILL CAUSE DAMAGE TO THE JOINTS

double: 135cm×190cm

Component of Carton A	Component of Carton B
(1) Head Board×1 	(3) Side Rail×2 
(2) Foot Board×1 	(5) Center Rail×1 
(4) End Rail×2 	
(6) Wooden Slats×28 	(8) Plastic end cap×32 (spare 4pcs) 
(7) Support Leg×3 	(9) Plastic center cap×16 (spare 2pcs) 

Hardware List

(A) Connector ×4 	(B) Connecting bolt 74mm ×4 	(C) M8 Nut ×4 	(D) Ø8 Spring washer ×4 
(E) Ø10×40 Dowel ×8 	(F) M6×20 Bolt ×4 	(G) M8 ×35 Bolt ×3 (already inserted into support legs) 	(H) Ø8 Washer ×3 
(I) M6 Wing Nut ×4 	(J) M6×40 Bolt ×4 	(K) 4MM Allen key ×1 	(L) 5MM Allen key ×1 
			(M) Spanner ×1 

Step 1

- Insert Bolt (B) into headboard & footboard

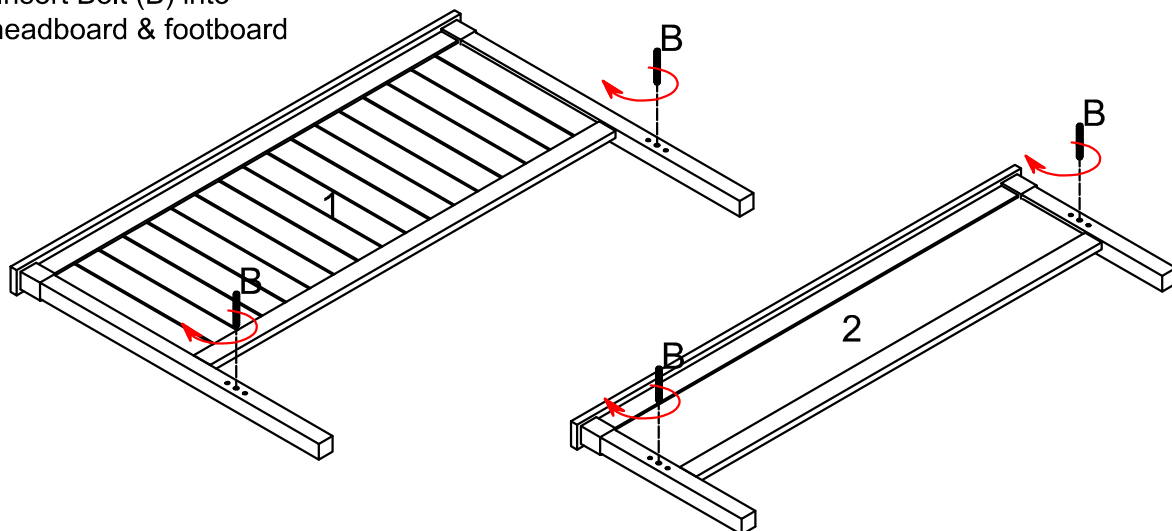

Step 2

- Attachment of side rails to headboard & footboard.

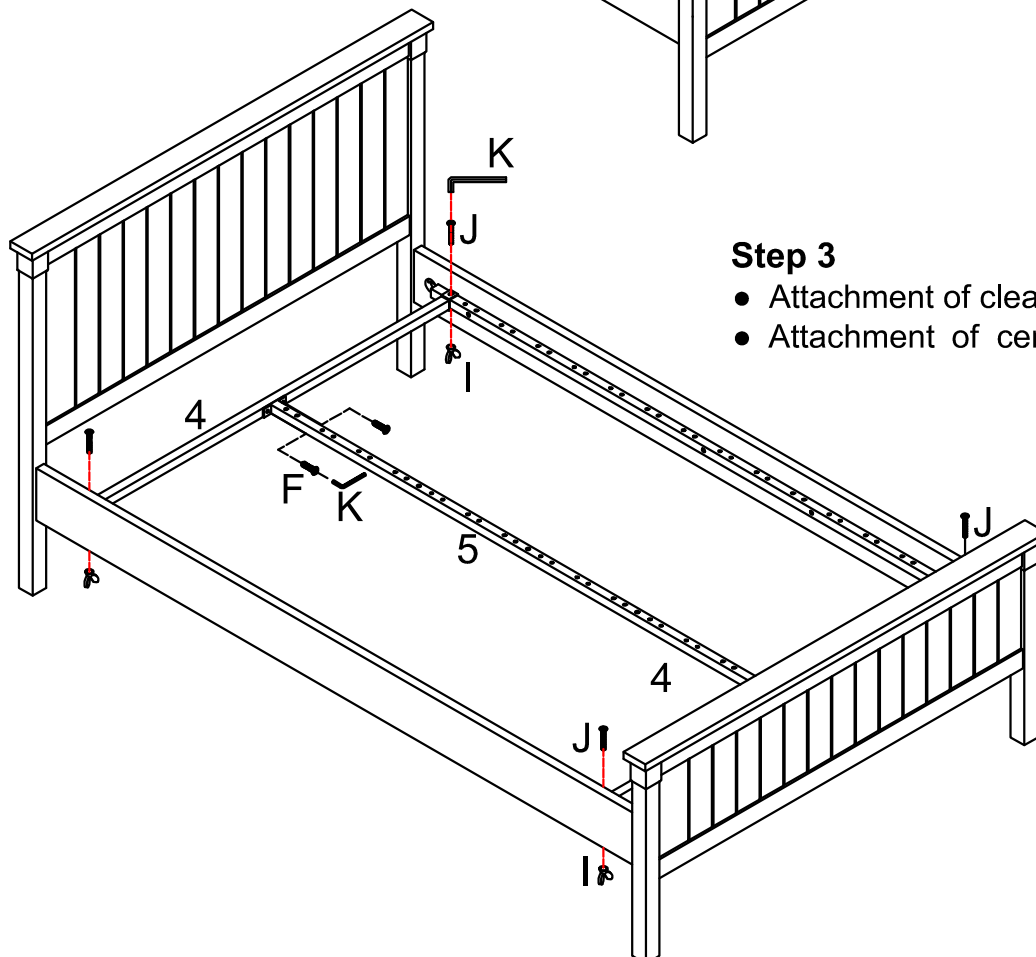
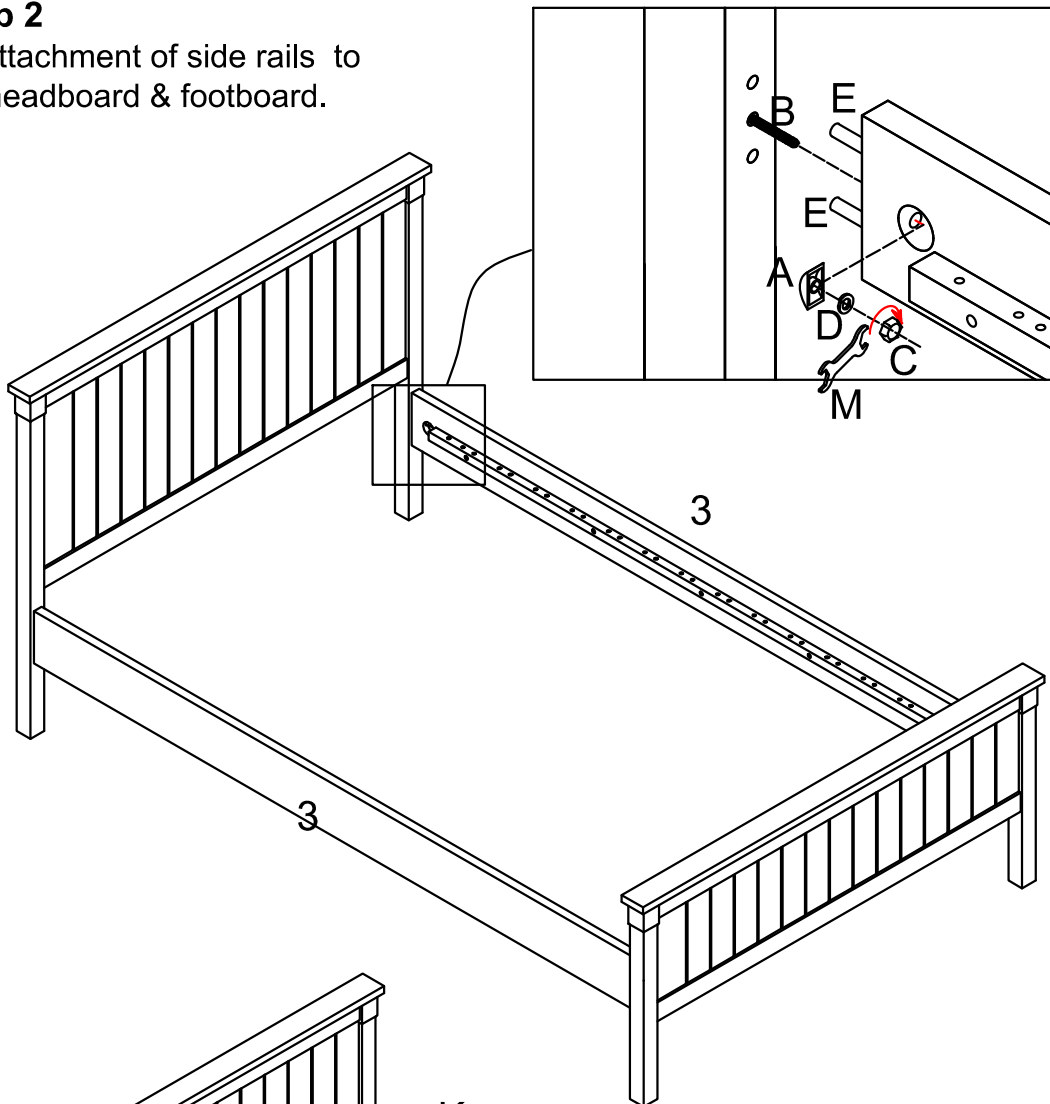

Step 3

- Attachment of cleat and side rail.
- Attachment of center rail to frame.

Step 4

- Attach support legs to the frame.

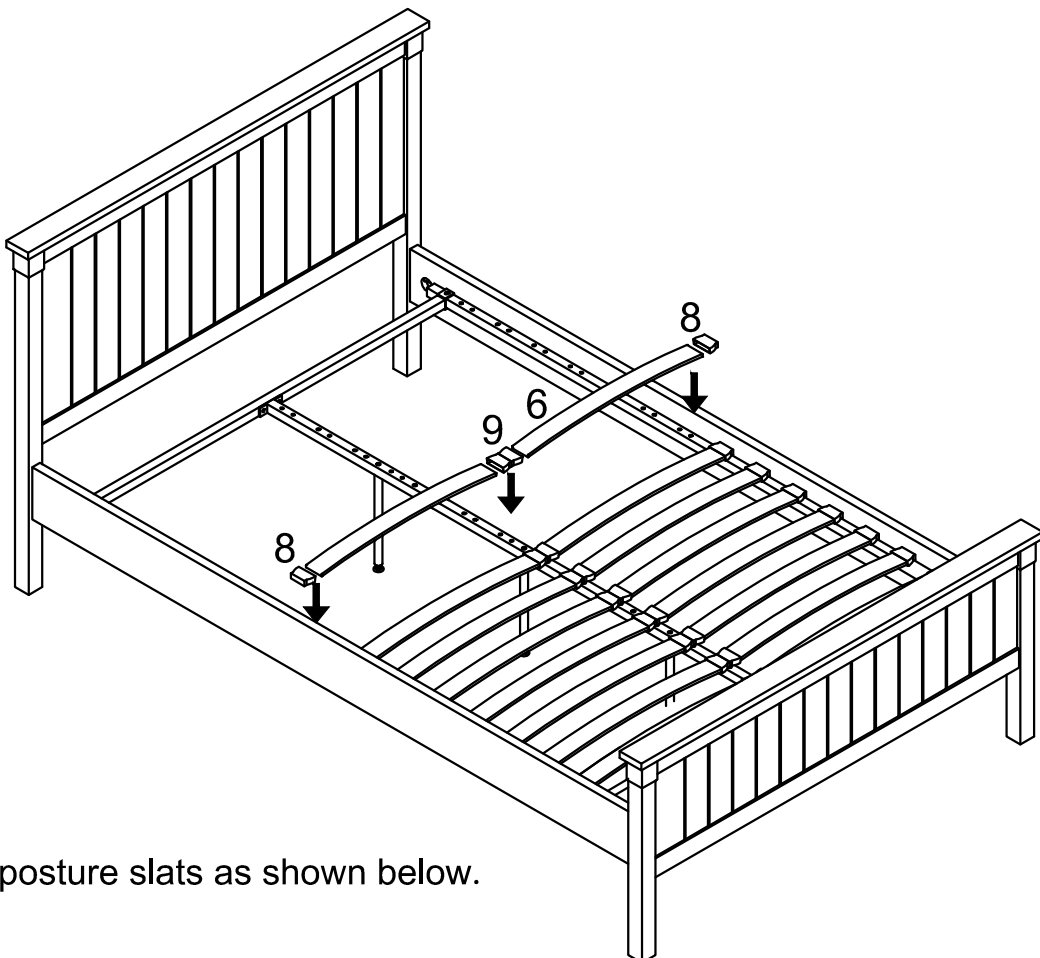
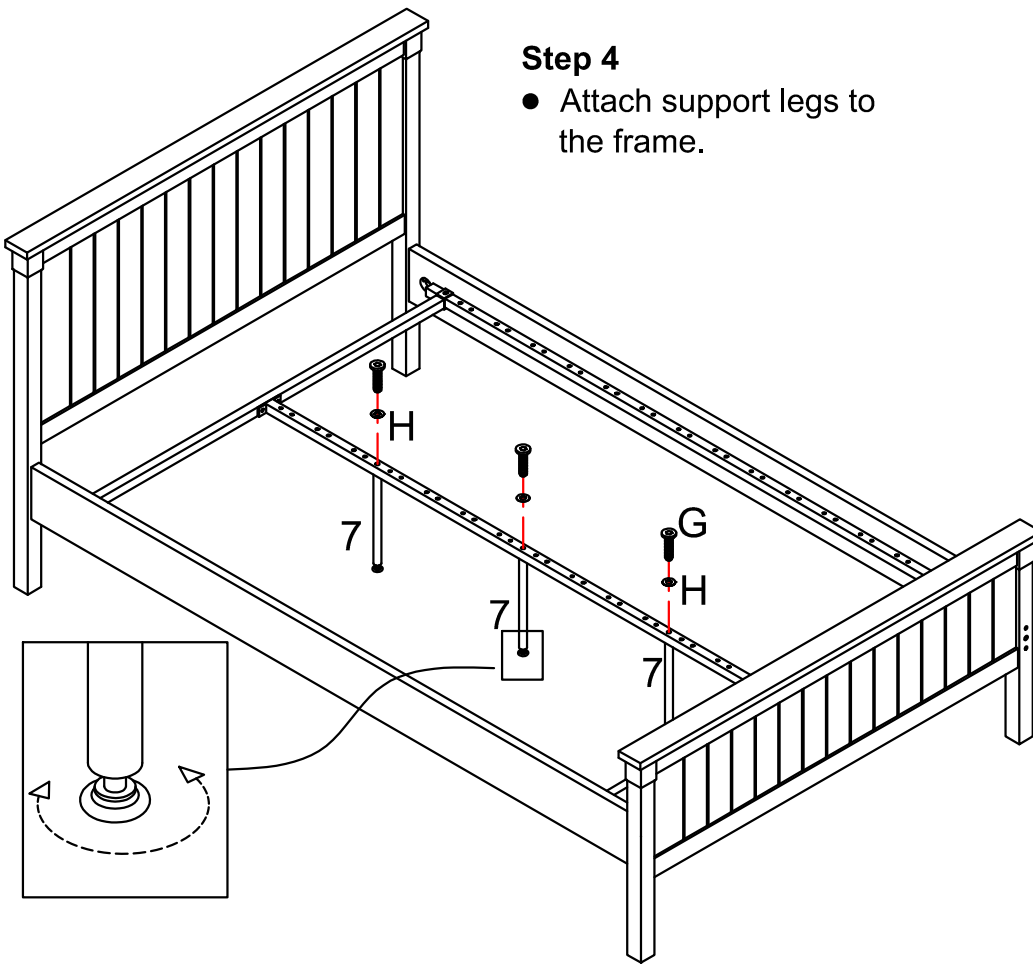
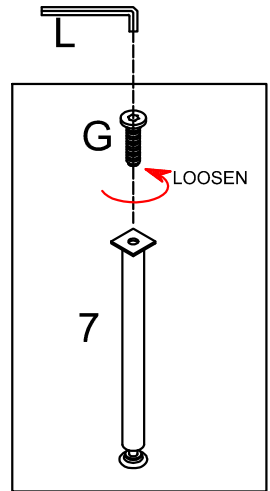

Step 5

- Slot posture slats as shown below.