

P.O.Number :
Please Keep This Number For
Future Reference
THIS FORMS PARTS OF
YOUR GUARANTEE!



Minimum two
person assembly

HATTIE BED 90 cm Assembly Instructions

Please keep these instructions for future reference.

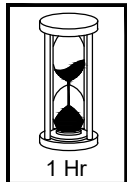

Approximate
Assembly Time

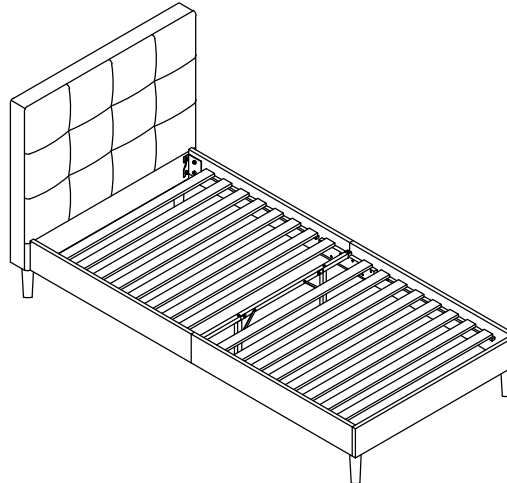

Product Details

STK799806 3' Bed Light Grey

Regrettably self-assembly items cannot be returned once assembly is part or fully completed unless the items are found to be faulty. Should you need to return the un assembled product, please repack in its original packaging.

Important Information

- We suggest you spend a short time reading through this leaflet and then follow the simple step-by-step instructions.
- Carefully check that you have all the parts before beginning assembly.
- Keep fittings out of children's reach and keep children well away from construction area.
- We suggest you retain these instructions for future reference.

Care Instructions

- Avoid exposing the furniture to excessive heat or direct sunlight as this can cause cracking or deterioration of the color.
- Periodically check & re-tighten any screws and fixings.
- Periodically dust lightly with a clean soft cloth.
- TAKE CARE WHEN MOVING THE FURNITURE AND NEVER DRAG THE PIECES ACROSS THE FLOOR, AS THIS WILL CAUSE DAMAGE TO THE JOINTS.

Frame Tested To BSEN1725
Fabrics and fillings to BS5852

Tips before you start!

1. Please check that all parts are present before you start the assembly of your furniture.
2. For ease and speed of assembly, we recommend that before you commence each step of the assembly, that you identify all the parts required for that step.
3. For larger items, please ensure that you have sufficient space and people (as indicated on page 1) to assemble your product safely. (Minimum Two Persons)
4. We recommend where possible, all items are assembled near to the area where they will be used, to avoid moving the product unnecessarily once assembled.
5. Please ensure that your bed is placed on a level floor area. (Avoid setting up and installing your bed on uneven floor surface)
6. For the protection of your furniture, we recommend that the product is placed on a protected surface during assembly to prevent any damage.
7. During assembly please take care not to over-tighten any fittings, as this may damage the product.

Care and Maintenance of your Furniture

- Please periodically check all fittings and re-tighten as necessary.
- To clean your item, please use a soft damp cloth and wipe clean.
- Please do not jump on your furniture.
- Never allow any kind of liquid to remain on your furniture. This can cause finishes to de-laminate. Take care when spraying Perfume and deodorants etc as the vapour can settle on the surface and cause damage.
- Periodically check the condition of your bed slats to ensure they are in good condition and have not become loose.
- It is important to never drag your bed as this can cause damage to the joints and the fixings. This may invalidate your guarantee.
- The bed should always be lifted into position or if moved for cleaning. Do not attempt to drag the bed across the floor.
- Periodically check the central support legs are perfectly upright and supporting the centre rail.

Components

A Headboard x 1
(3'-1010 x 840mm)

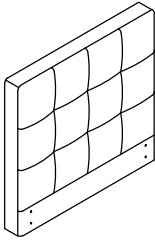

B Footboard x 1
(3'-970 x 150mm)

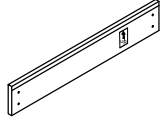

C Side Rail (Left)
Headboard end x 1
(3'-965 x 150mm)

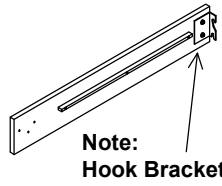

Note:
Hook Bracket

D Side Rail (Left)
Footboard end x 1
(3'-965 x 150mm)

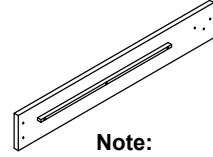

Note:
No Bracket

E Side Rail (Right)
Headboard end x 1
(3'-965 x 150mm)

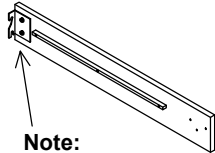

Note:
Hook Bracket

F Side Rail (Right)
Footboard end x 1
(3'-965 x 150mm)

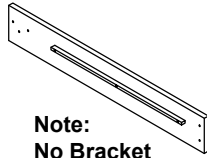

Note:
No Bracket

G Connecting Plate x 2
(25 x 55 x 448mm)

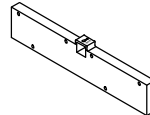

H Cross Stretcher x 1
(3'-25x925mm)

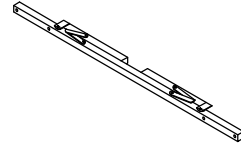

J Headboard Feet x 2
(150mm)



K Slatted system x 2
(3'-14 x 50 x 928mm x 8 slats)

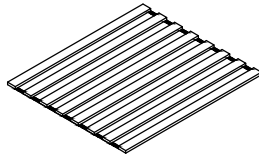

L Footboard Feet x 2
(280mm)



Note: All parts packed inside the zipped cover on the back of headboard.

Hardware List

M M8 x 12mm
x 12



N Allen Key (M5)
x 1



O M8 x 20mm
x 8



P M8 x 30mm
x 4

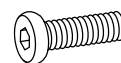

Q M8 x 40mm
x 14

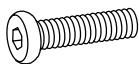

R M8 x 50mm
x 2

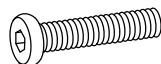

S M8 x 17mm
x 28



Note: All parts packed inside the zipped cover on the back of headboard.

Step 1

ALL parts and components are packed inside a zipped cover on the back of the Headboard.

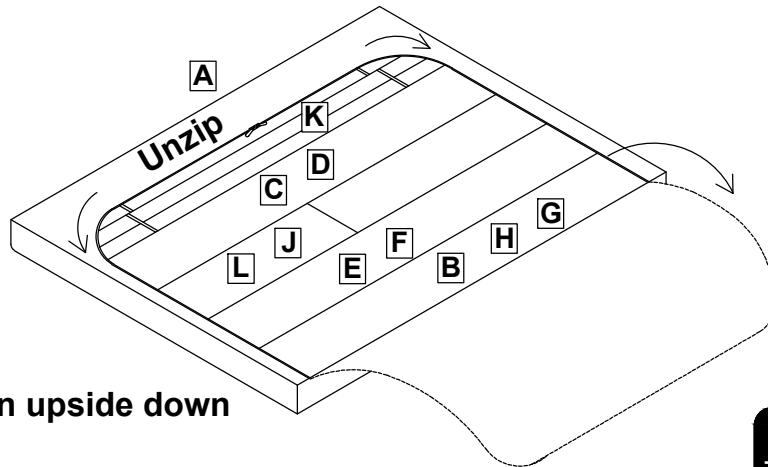

Shown upside down

WARNING!

The headboard is heavy.
Lift with care.

Step 2

- Open out the legs on cross stretcher **H**.
- Ensure hinges are locked as shown and secured using fixings **Q** and **S**.

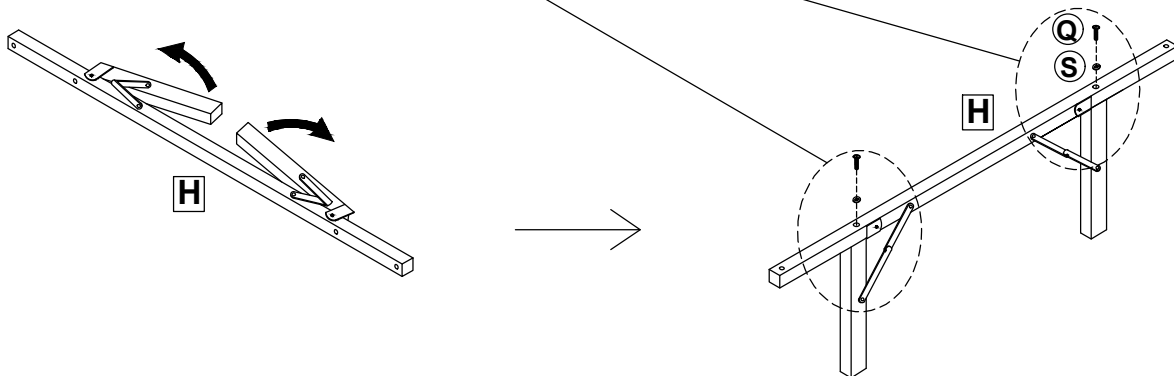
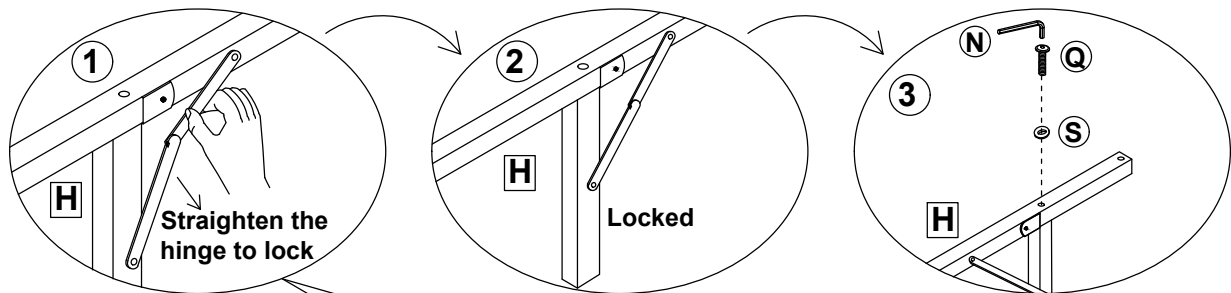

Required Fixings for this step.

N x 1

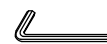

Q x 2



S x 2



Step 3

- Assemble side rails using connecting plates **G** and fixings **Q** and **S**.

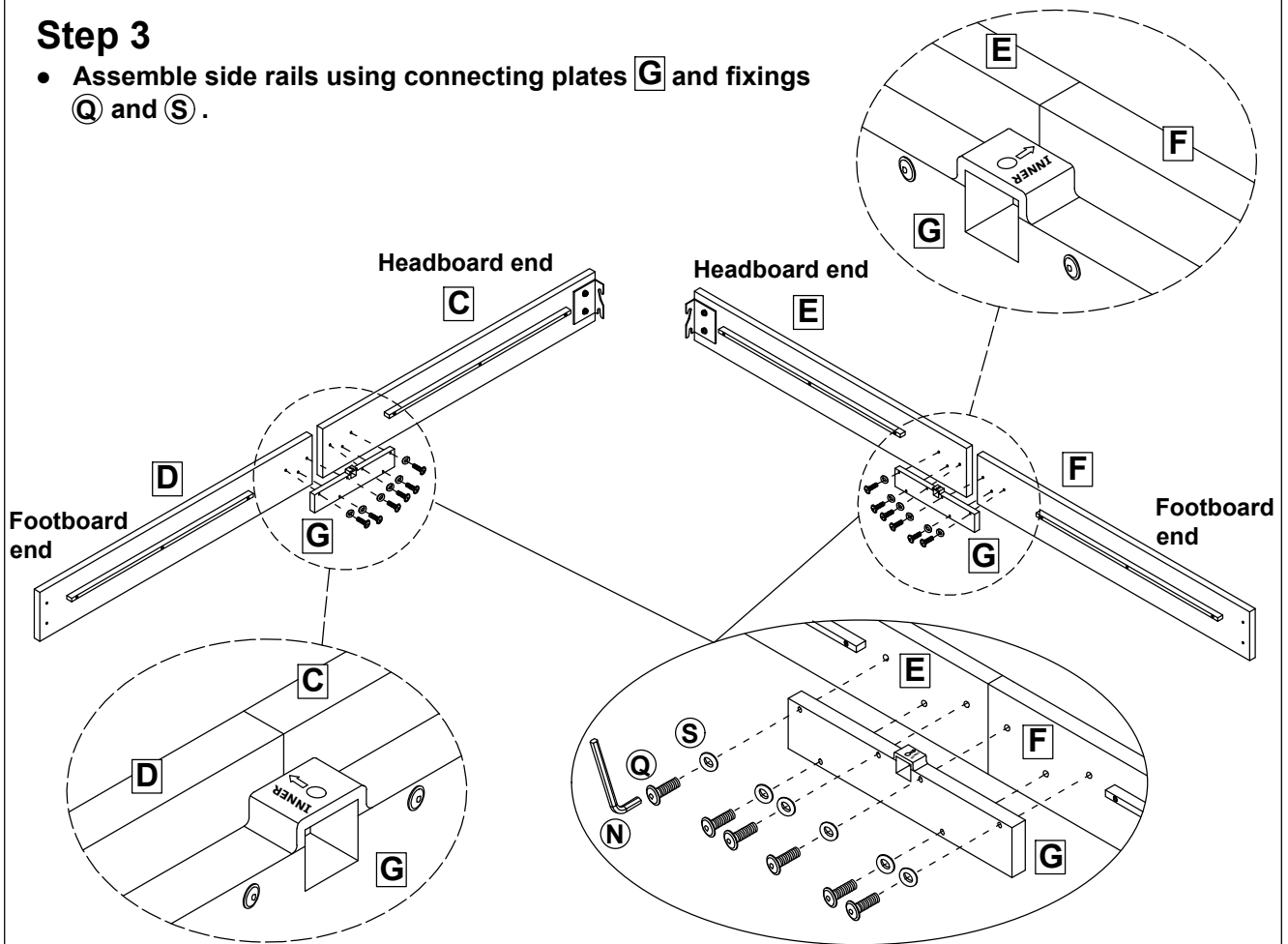

Required Fixings for this step.

N x 1



Q x 12

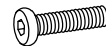

S x 12



Step 4

- Attach footboard feet **L** to footboard **B** using fixings **O**, **M** and **S**.

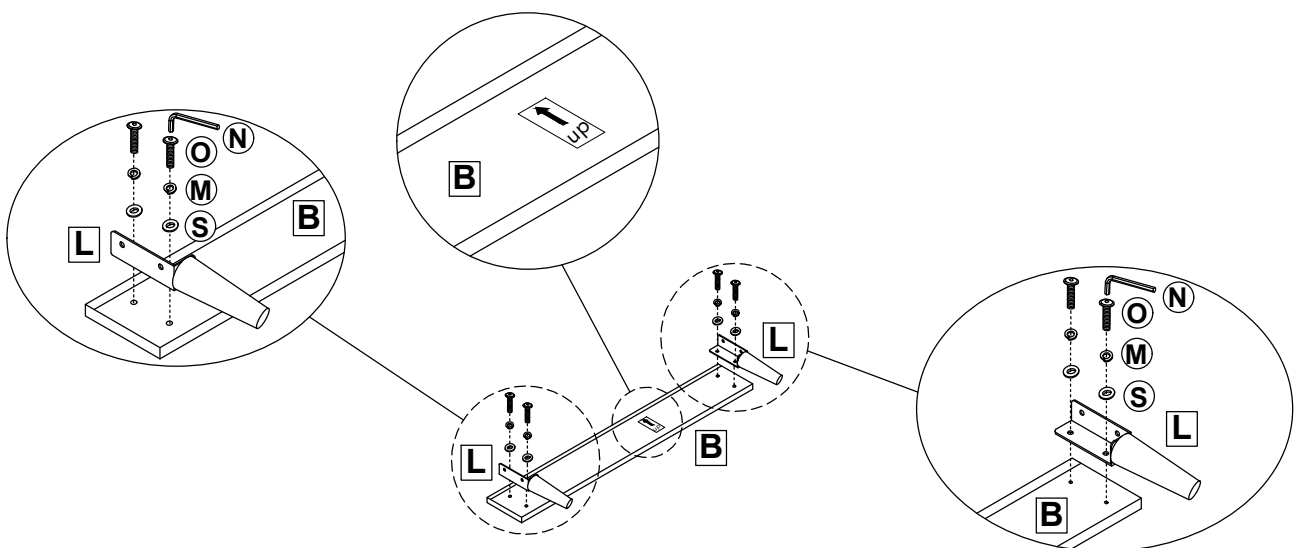

Required Fixings for this step.

M x 4



N x 1



O x 4



S x 4



Step 5

- Locate side rails into connecting plates **G**.
- Secure using fixings **R** and **S**.

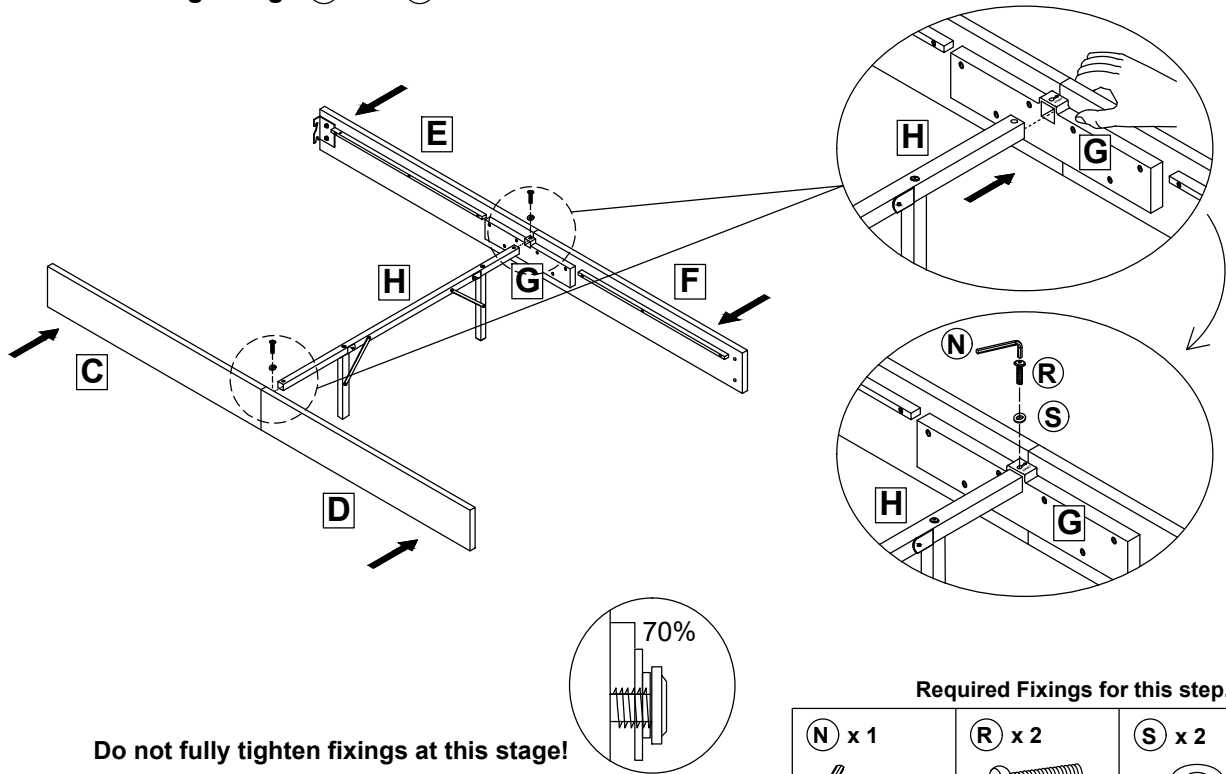

Step 6

- Assemble footboard to side rails using fixings **O**, **S** and **M**.

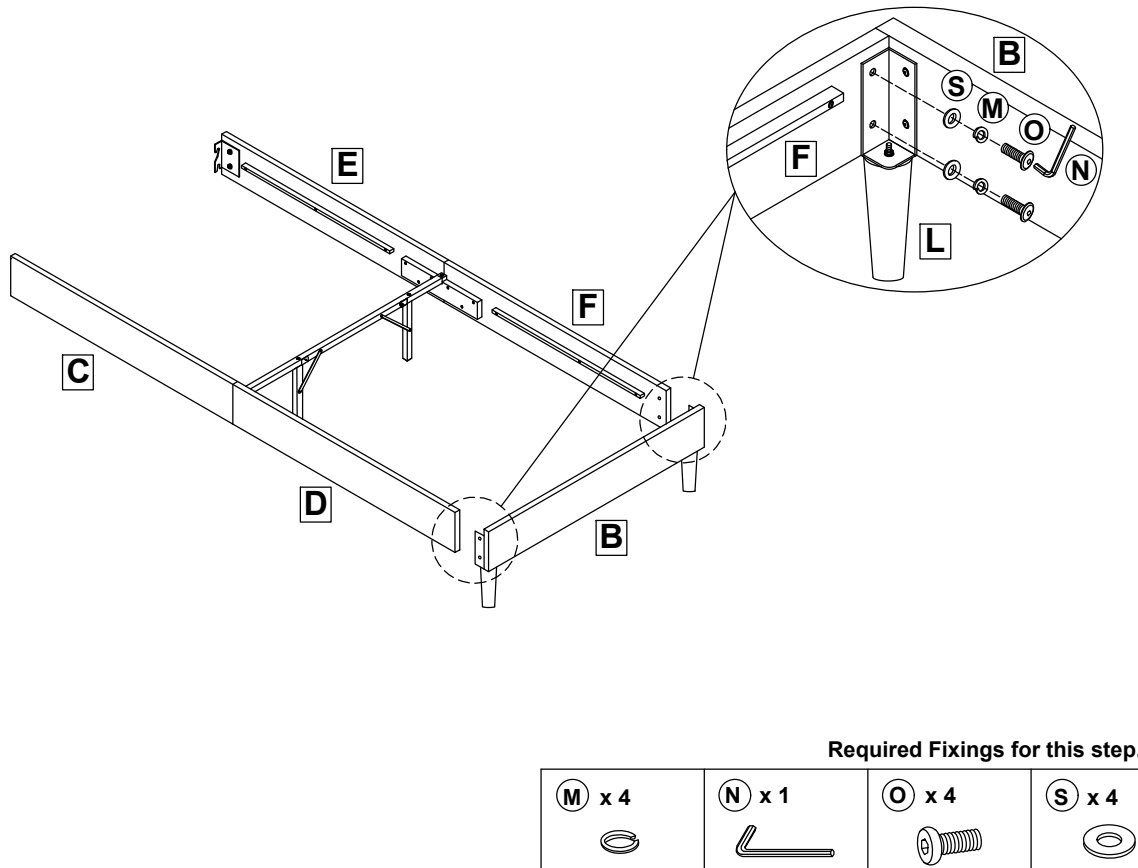



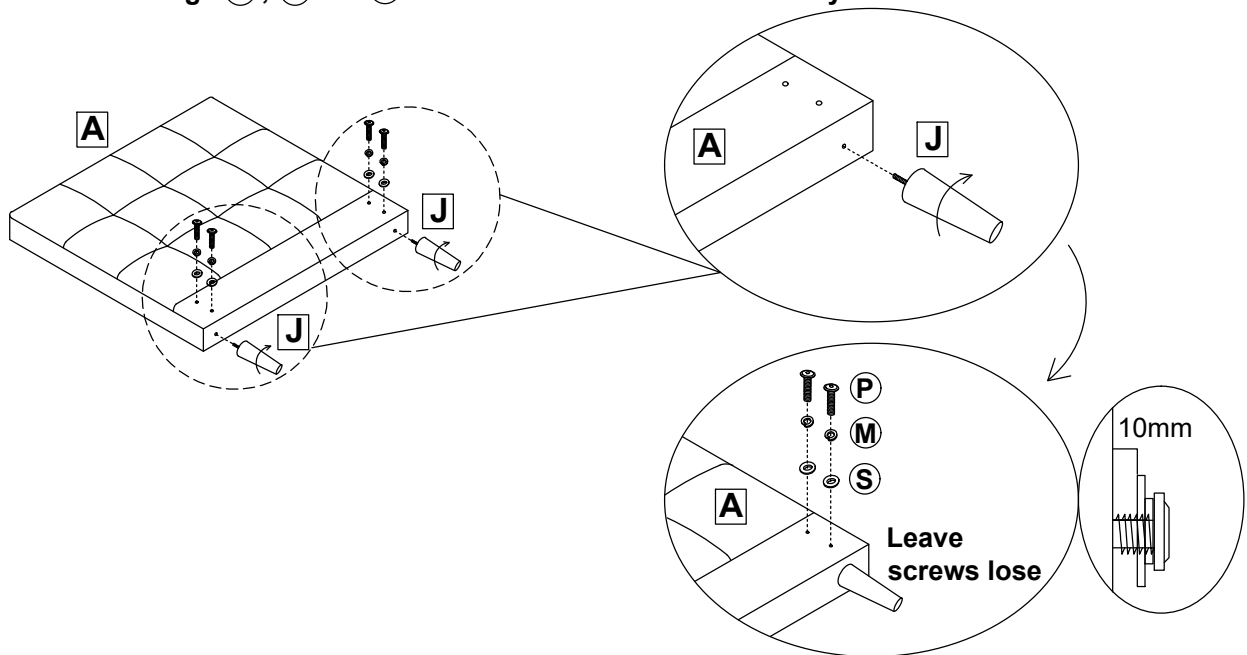

Step 7

- Screw headboard feet **J** into headboard **A**.
- Screw fixings **P**, **M** and **S** into the headboard but leave very loose.



Required Fixings for this step.

M x 4 	N x 1 	P x 4 	S x 4 
---	--	---	---

Step 8

- With help, lift the side rails and hook them over the fixings in headboard **A**.
- Ensure the frame is square before tightening all fixings.

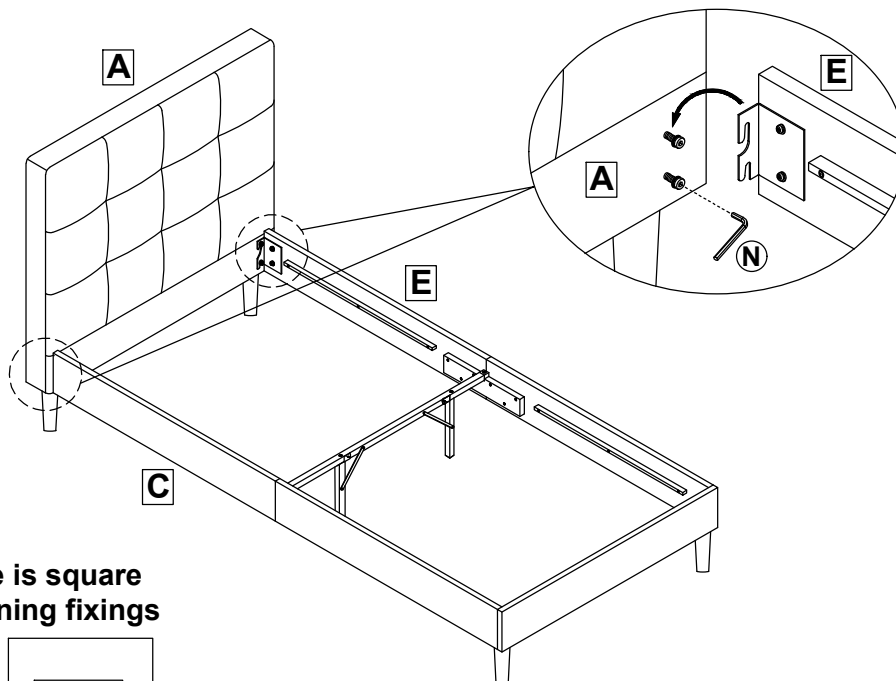

Ensure frame is square
before tightening fixings

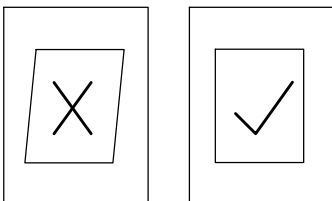

Required Fixings for this step.

N x 1 

Step 9

- Open out the base slatted system **K** and locate them into position. They are secured by the velcro strips.
- Gently lay the slats onto the centre support and side rails. Evenly space out the slats by gently pulling and press the velcro strips together to hold them in place.

