

P.O.Number :
Please Keep This Number For
Future Reference
**THIS FORMS PARTS OF
YOUR GUARANTEE!!**

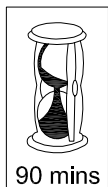

**MINIMUM TWO
PERSON ASSEMBLY**



**APPROXIMATE
ASSEMBLY TIME**

bensons
for beds

SILVIA OTTOMAN BEDFRAME 120 / 135 / 150 cm
STK804304 / STK804305 / STK804306

Assembly Instructions

Please keep these instructions for future reference.

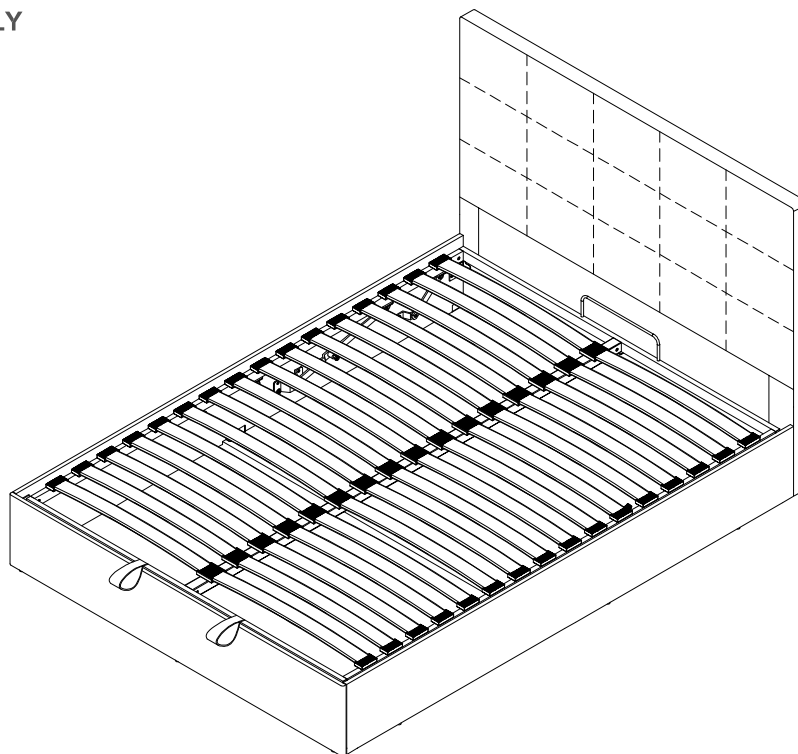

Regrettably self-assembly items cannot be returned once assembly is part or fully completed unless the items are found to be faulty. Should you need to return the unassembled product, please repack in its original packaging.

Important Information

- We suggest you spending a short time reading through this leaflet and then follow the simple step-by-step instructions.
- Carefully check that you have all the parts before beginning assembly.
- Keep fittings out of children's reach and keep children well away from construction area.
- We suggest you retaining these instructions for future reference.

Product Information

- Conforms to BSEN 1725.
- Upholstered Fabric & Fillings Conform to BS5852.
- Front lift up storage bed.

Care Instructions

- Avoid exposing the furniture to excessive heat or direct sunlight as this can cause cracking or deterioration of the color.
- Periodically check & re-tighten any fastener.
- Periodically dust lightly with a clean soft cloth.
- Any spills should be removed immediately with a damp cloth.
- **TAKE CARE WHEN MOVING THE FURNITURE AND NEVER DRAG THE PIECES ACROSS THE FLOOR, AS THIS WILL CAUSE DAMAGE TO THE JOINTS.**

Component of Carton 1

(A) Headboard x 1

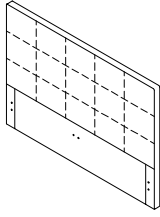

(B) Footboard x 1

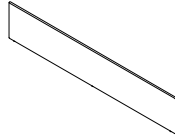

(C) Non Woven Floor x 1

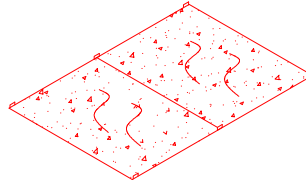

Component of Carton 2

(D) Side Rail-Left x 1

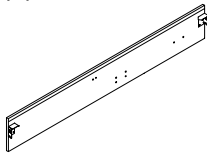

(E) Side Rail-Right x 1

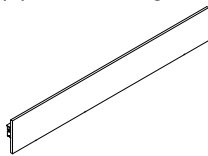

(F) Support Rail x 1

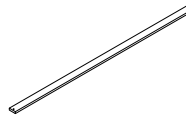

Component of Carton 3

(G) Lift Up Mechanism
Left x 1

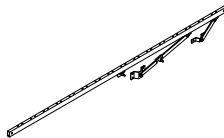

(H) Lift Up Mechanism
Right x 1

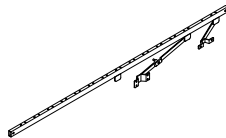

(I) Centre Rail x 1

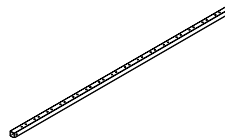

(J) Lift Up Mechanism
Front x 1

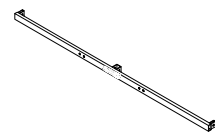

(K) Lift Up Mechanism
Back x 1

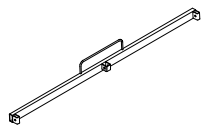



Component of Carton 4

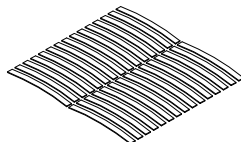













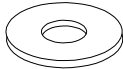

(L) Posture Slat
x 30 (4 FT / Double)
x 32 (King)



Hardware List (in Carton 1)

| | | |
|--|---|--|
| <p>(M) M8 x 20mm x 8 (Pre-Installed)</p>  | <p>(N) Lock Device (Frame Attachment) x 1</p>  | |
|--|---|--|



Hardware List (in Carton 2)

| | | | |
|--|--|---|---|
| <p>(O) M6 x 15mm x 8</p>  | <p>(P) M6 x 35mm x 2</p>  | <p>(Q) JCN Nut M6 x 15mm x 10</p>  | <p>(R) M6 Washer x 10</p>  |
| <p>(S) M6 Spring Washer x 6</p>  | <p>(T) M8 x 20mm x 20</p>  | <p>(U) M8 Washer x 20</p>  | <p>(V) M8 Nut x 4</p>  |
| <p>(W) Spanner x 1</p>  | <p>(X) Screw Driver x 1</p>  | <p>(Y) Allen Key M4 x 2</p>  | <p>(Z) Rubber Pad x 8</p>  |
| <p>(AA) 'L' BRACKET x 2</p>  | <p>(AB) M4 x 12mm x 4</p>  | <p>(AC) Strap Handle x 2</p>  | <p>(AD) L Support Bracket x 4</p>  |
| <p>(AE) Gas Cylinder x 2 4 FT - 550N DOUBLE - 550N KING - 650N</p>  | | | |

Hardware List (in Carton 3)

| |
|--|
| |
|--|

Hardware List (in Carton 4)

| | | |
|--|---|--|
| <p>(AF) End Cap x 30 or 32</p>  | <p>(AG) Middle Cap x 15 or 16</p>  | |
|--|---|--|

Step 1

- Loosen the bolts located in the head end (A) and foot end (B). (Note: only loosen the bolts Do **Not** remove them.)
- Attach the L Support Bracket (AD) to the head end and foot end as shown. Fix the L Support Bracket using screw (T) and washer (U).
- Tighten the screw using screw driver (X).

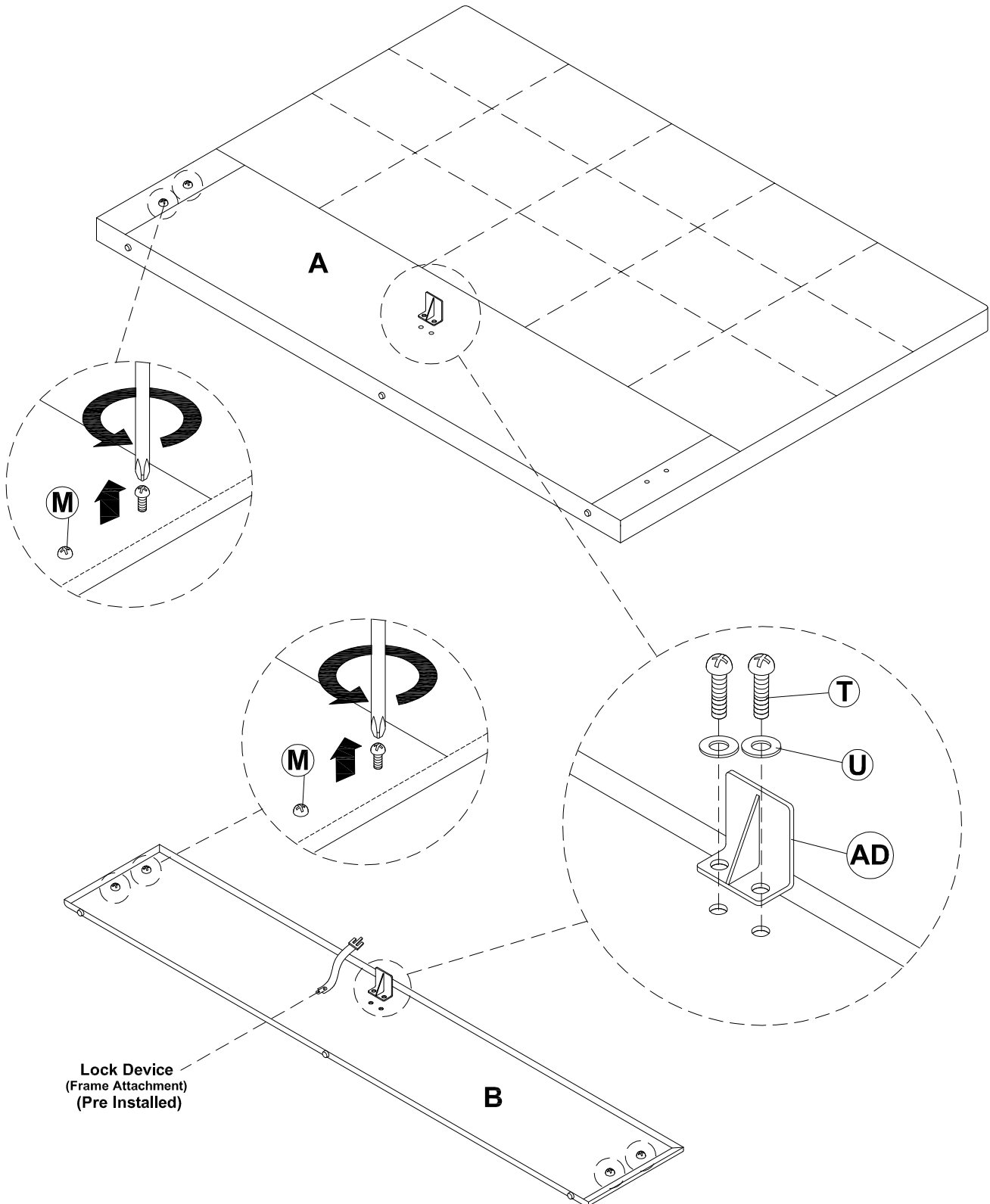

Step 2

- Attach the L Support Bracket (AD) to the side rail (D) and (E) as shown. Fix the L Support Bracket using screw (T) and washer (U).
- Tighten the screw using screw driver (X).

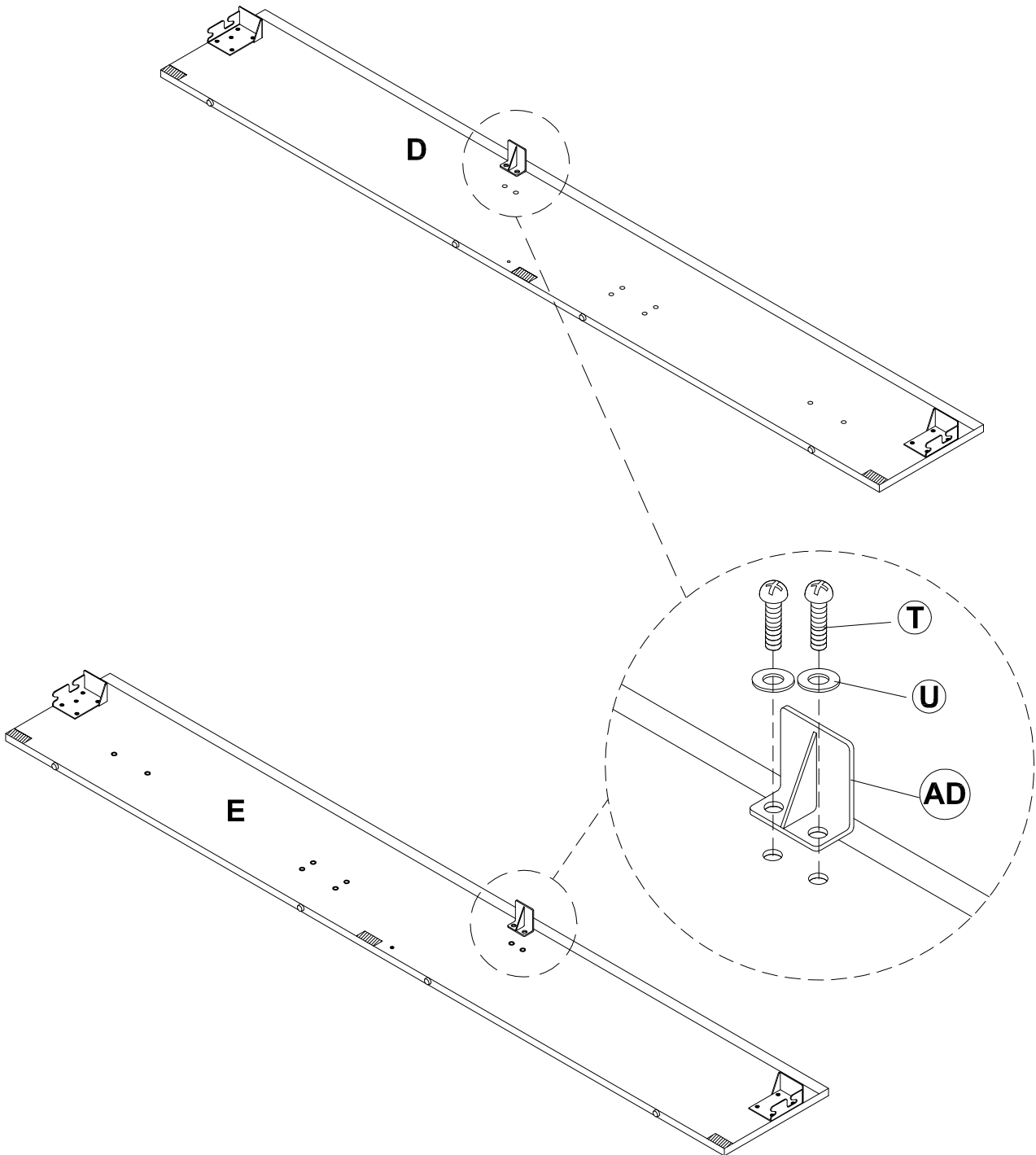

Step 3

- Hook the side rail over the bolts as shown.
- Repeat the action on the opposite side.
- Leave bolts finger tight (Do Not Tighten).

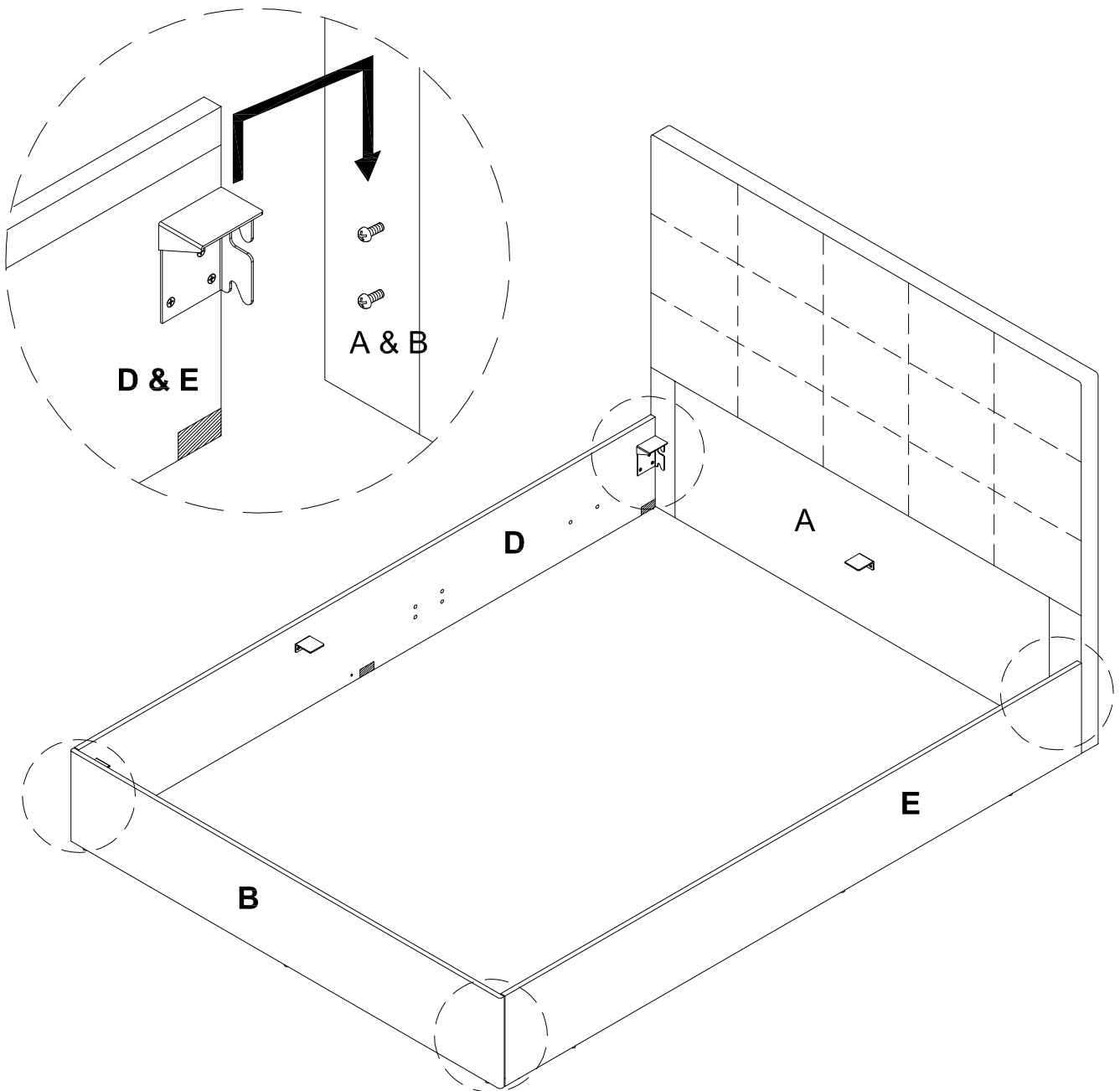

Step 4

- Carefully place the Non Woven Floor (C) inside the bed as shown.
- Attach the velcro tape to the side rail. Flatten out the Non Woven panel.
- Fully tighten the Side Rail (D) & (E), head end & foot end.

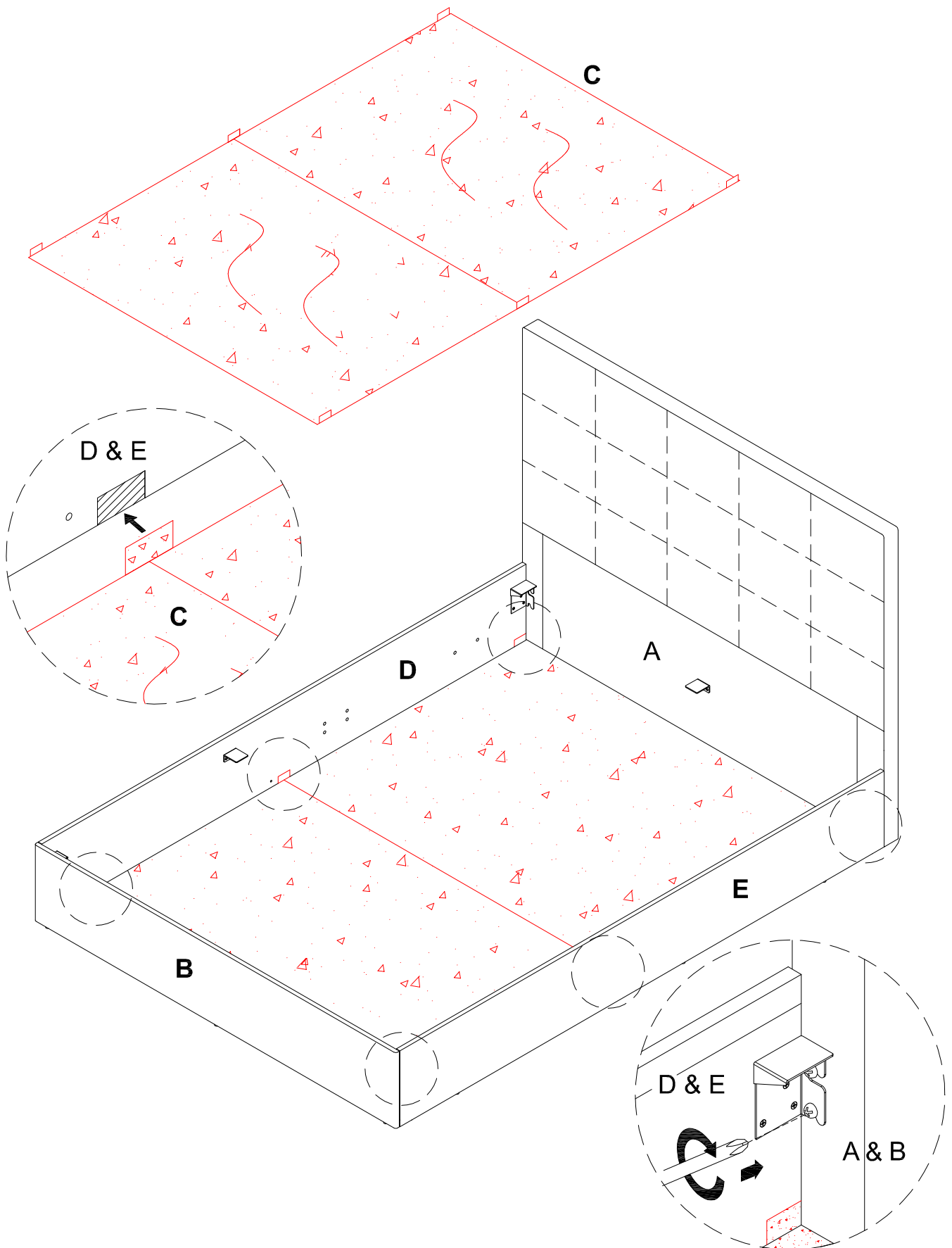

Step 5

- Attach the 'L' Shape Bracket (AA) to the support rail (F) using screw (AB).
- Attach the full rail to the inside of the ottoman as shown.

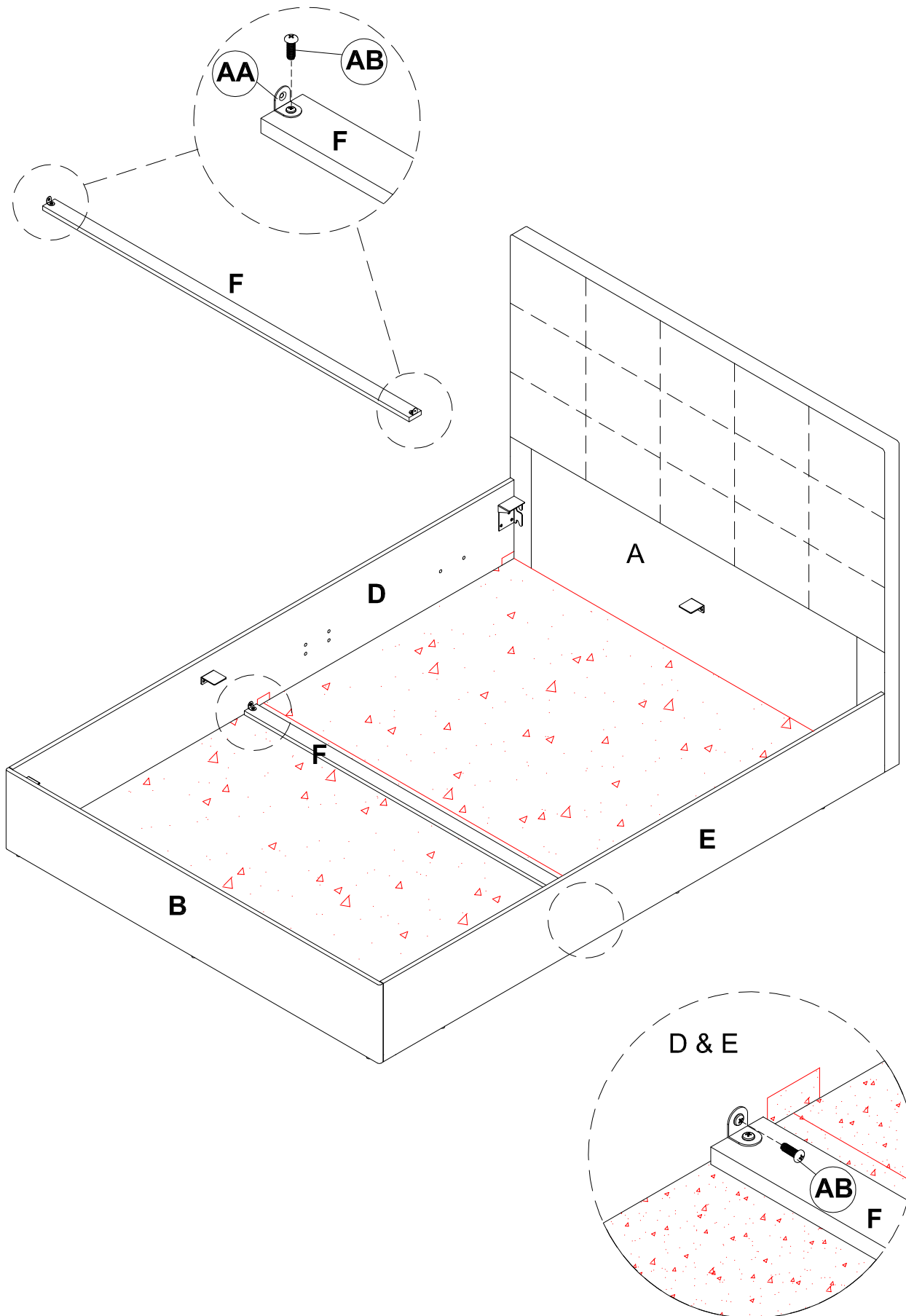

Step 6

- Attach the Lock Device (Frame Attachment)(N) to the Metal Centre Rail (I) as shown .
- Insert Lift Up Mechanism front (K), Lift up Mechanism back (J) & Centre Rail (I) to the Lift Up Mechanism Left (G) & Right(H).
- Assemble the Lift Up Mechanism Left (G) & Right(H) with the screw (O), JCN Nut (Q), Washer (R) & Spring Washer (S) using Allen Key (Y) as shown.
- Assemble the Centre Rail (I) with the screw (P), JCN Nut (Q), Washer (R) & Spring Washer (S) using Allen Key (Y) as shown.
- Fully tighten all the screws.

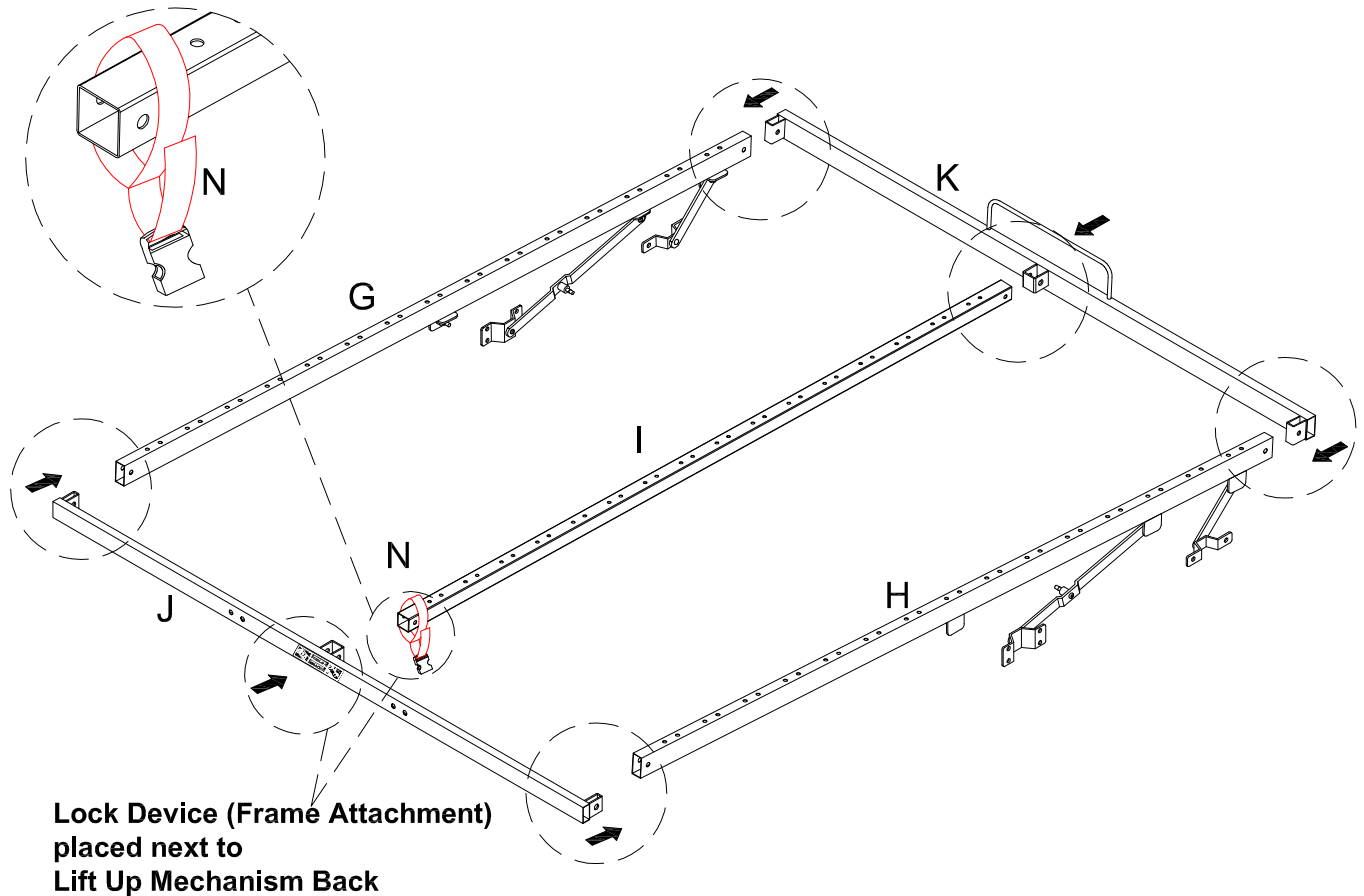

(STEP 6.1)

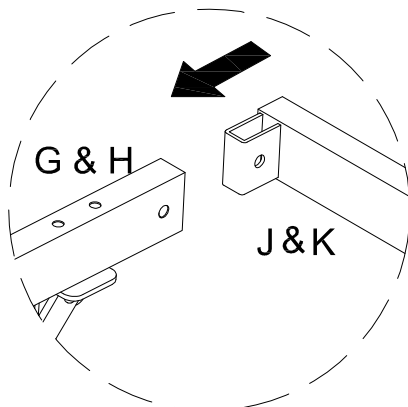

(STEP 6.2)

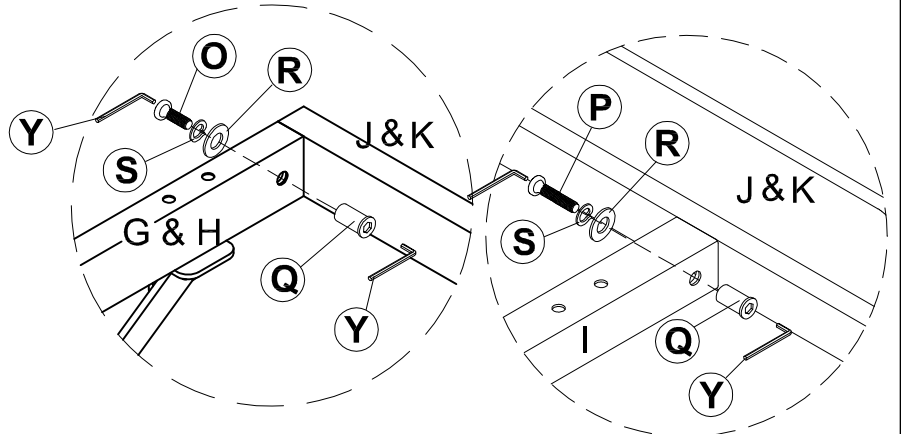

Step 7

- Attach the Strap Handle (AC) to the Lift up Mechanism back (J) as shown .
- Assemble the Strap Handle (AC) with the screw (O), JCN Nut (Q), Washer (R) using Allen Key (Y) as shown.
- Fully tighten all the screw.

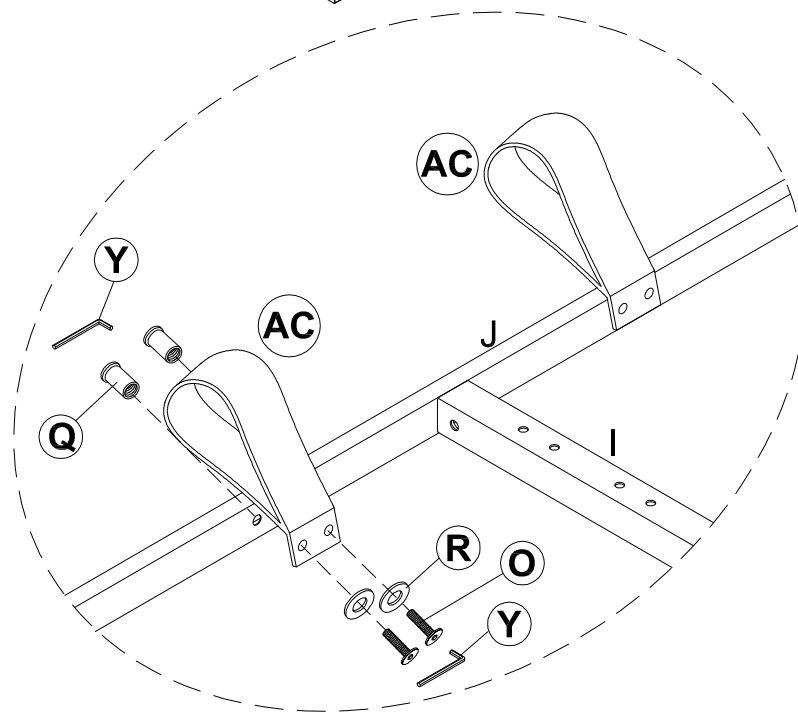
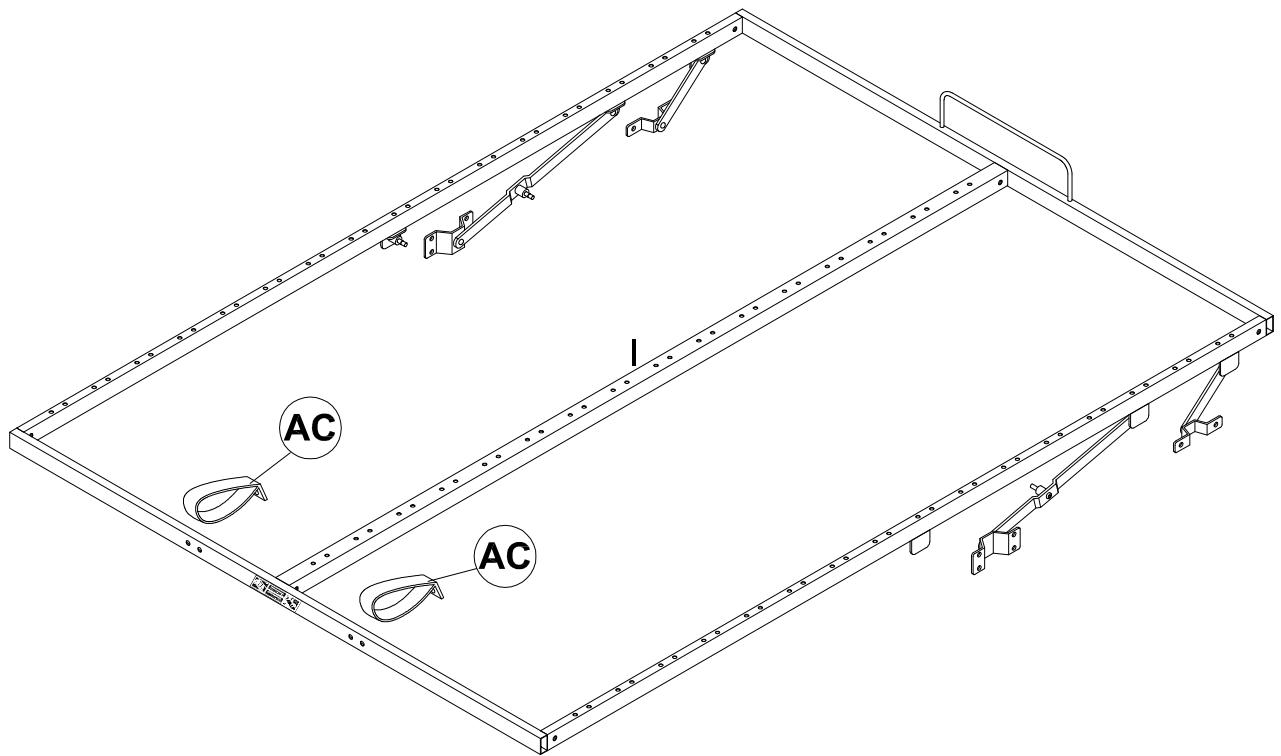

Step 8

- Tear off the double sided tape from the Rubber Pad (Z) & attach it to the side rail bracket & L Support Bracket as shown .

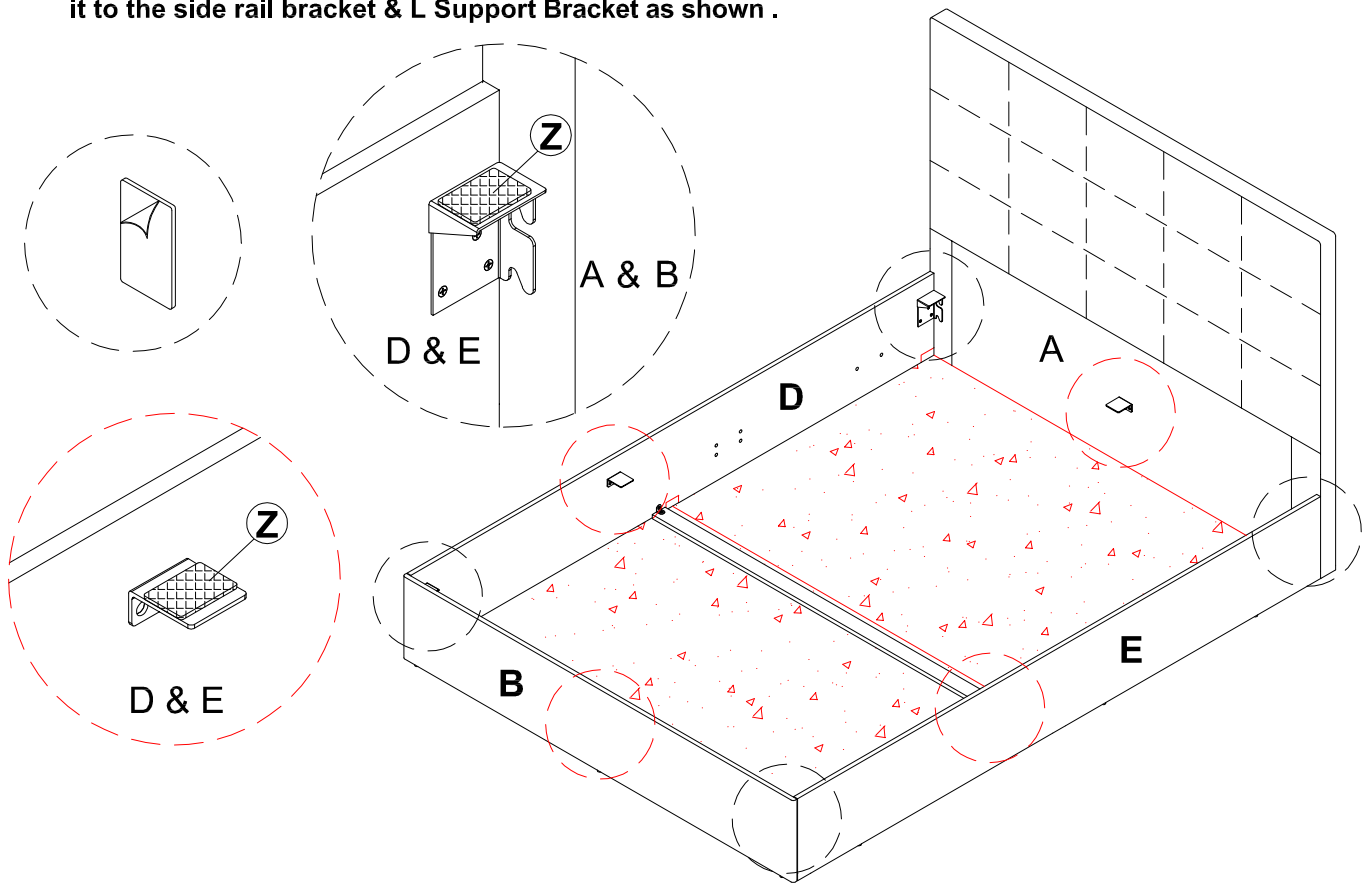

Step 9

- Carefully place the Lift Up Mechanism on the side rail hook bracket & L Support Bracket.

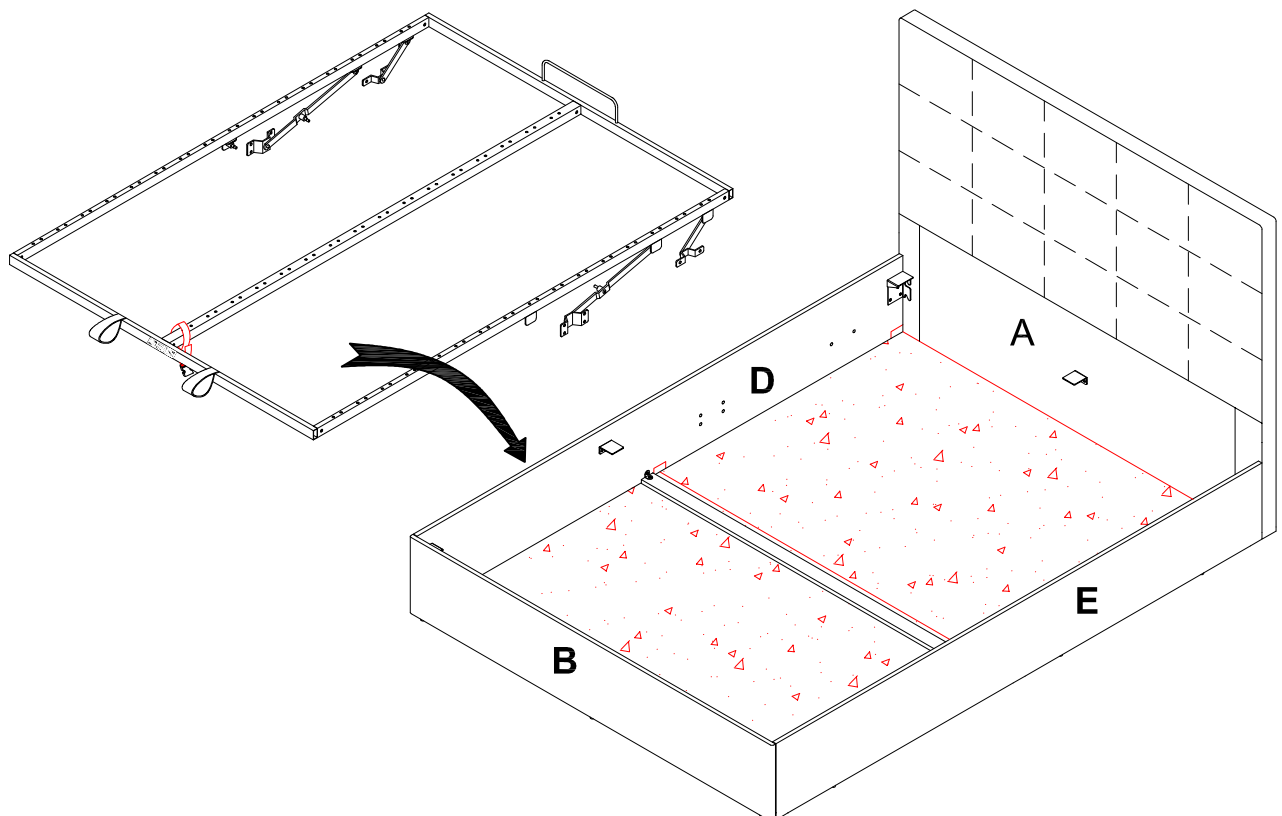

Step 10

- Assemble it to the side rail with screw (U) & washer (T) provided as shown.

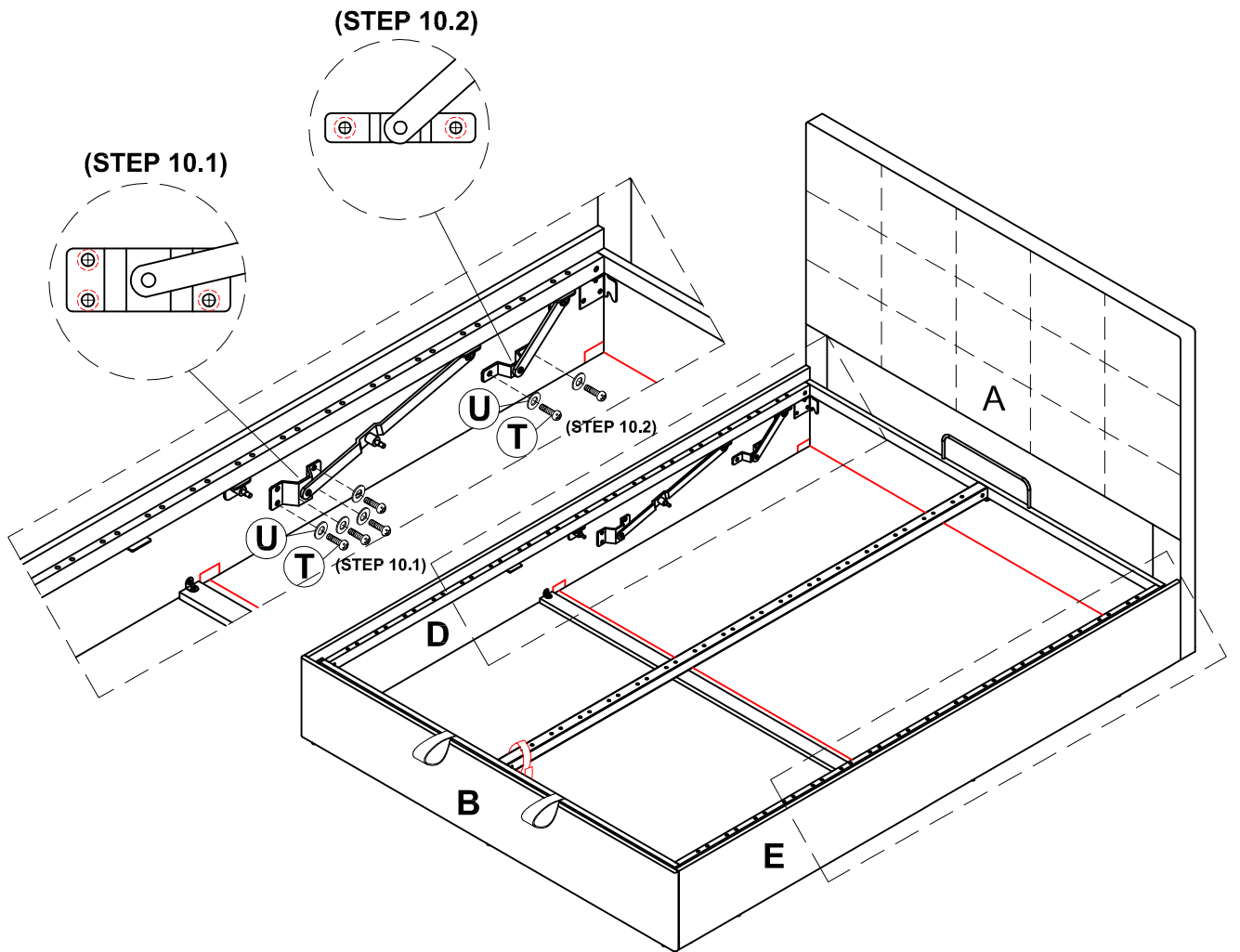

Step 11

- Attach middle cap and end cap to the bend wood slat.
- Push the middle cap into the centre rail first.
Then end caps to Lift Up Mechanism (side rail).

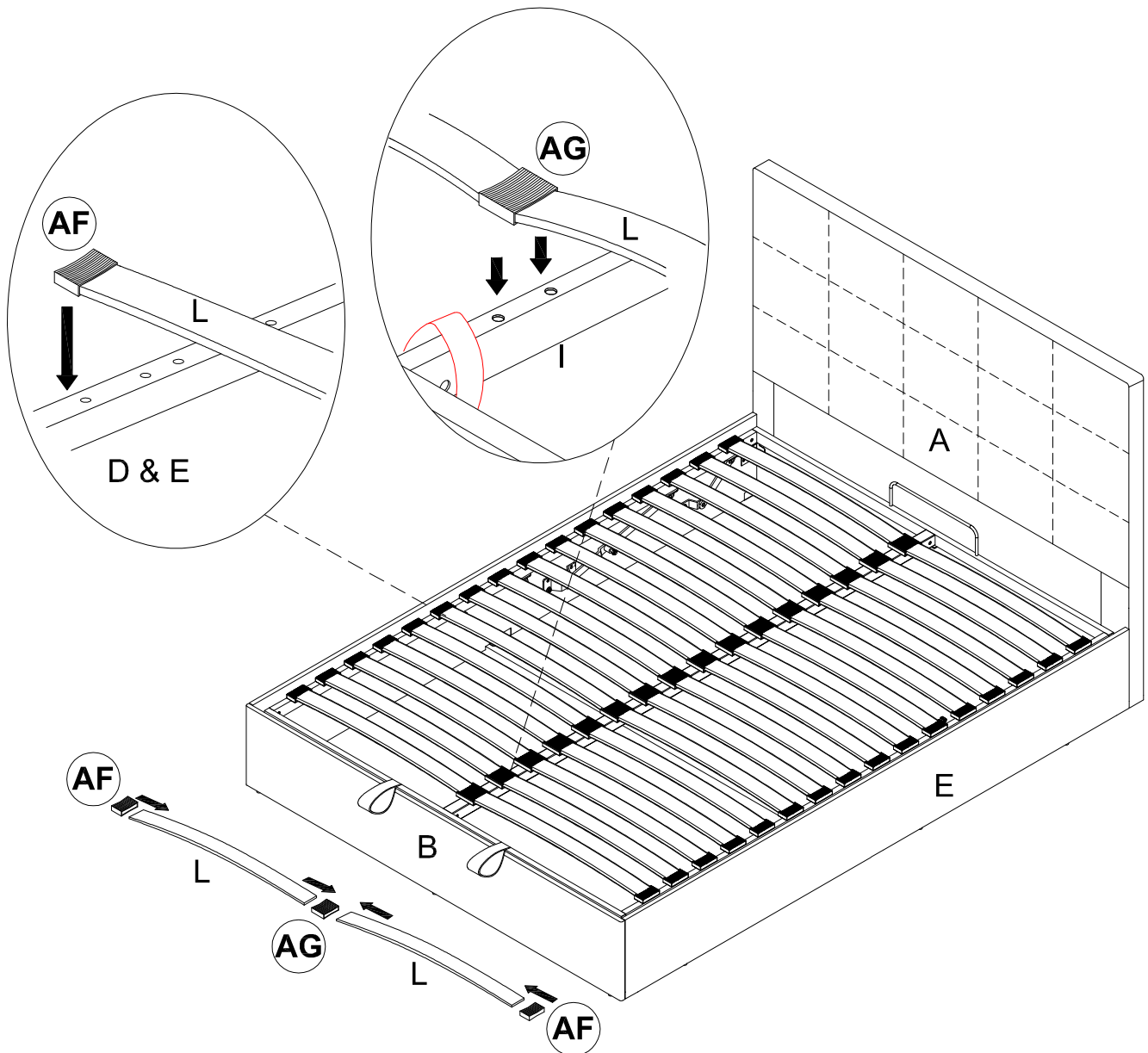

(DISMANTLE THE SLAT CAP)

Step 12

- Firstly, remove both end cap from Lift Up Mechanism & remove one side of slats as shown.

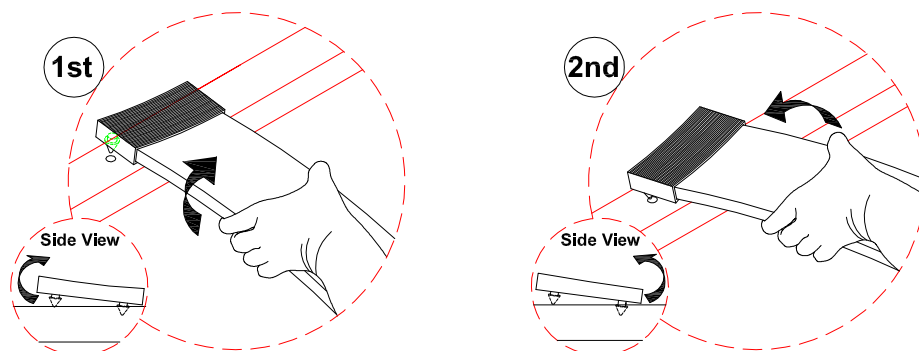

Step 13

- To attach the gas cylinder (AE) to the Lift up Mechanism use Nut (V) & Spanner (W) provided as shown.

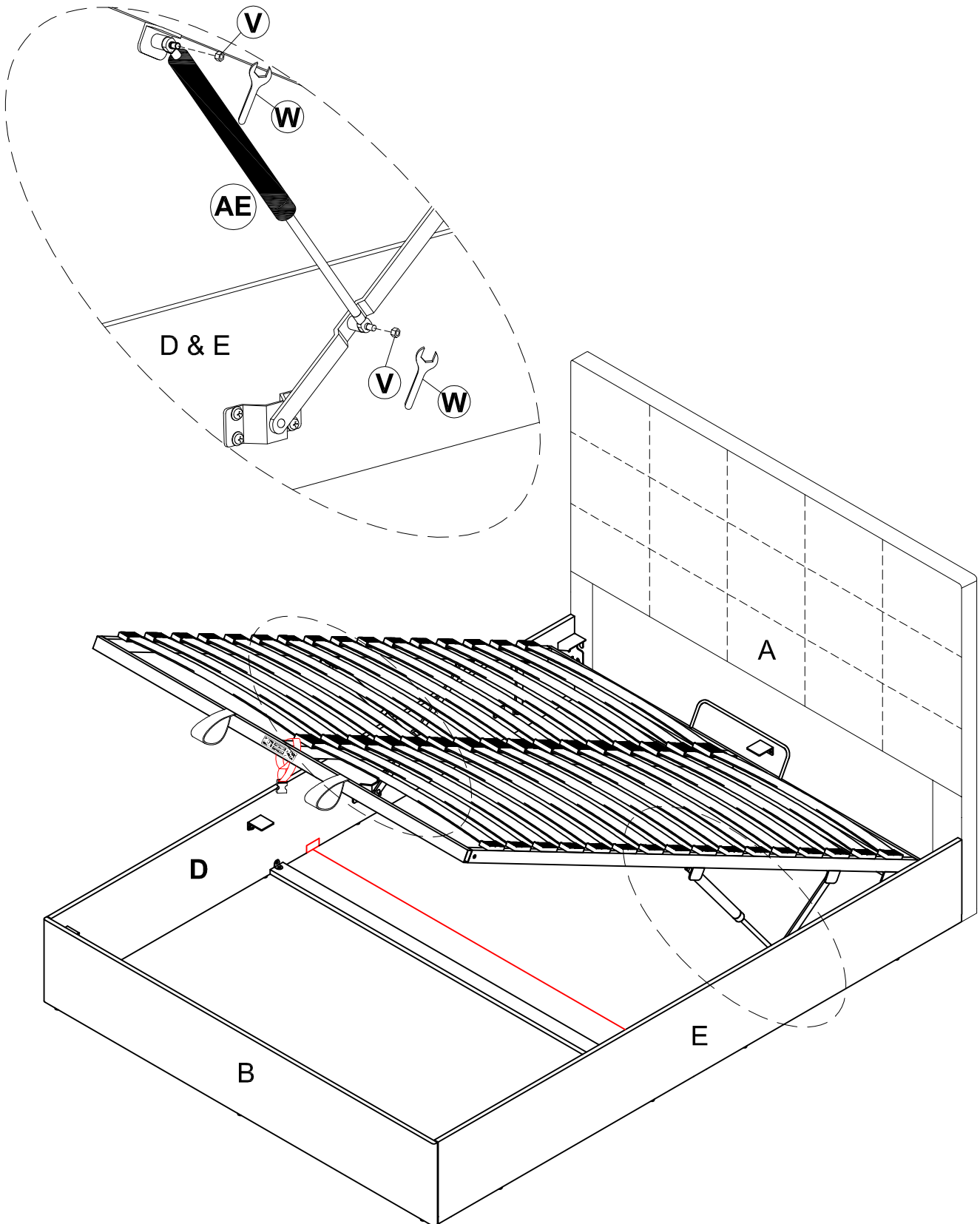

Step 14

- Make sure the bed corners are always square at 90 degree's before closing the sleeping base.
- Push the mechanism down to lock the Lock Device as shown.

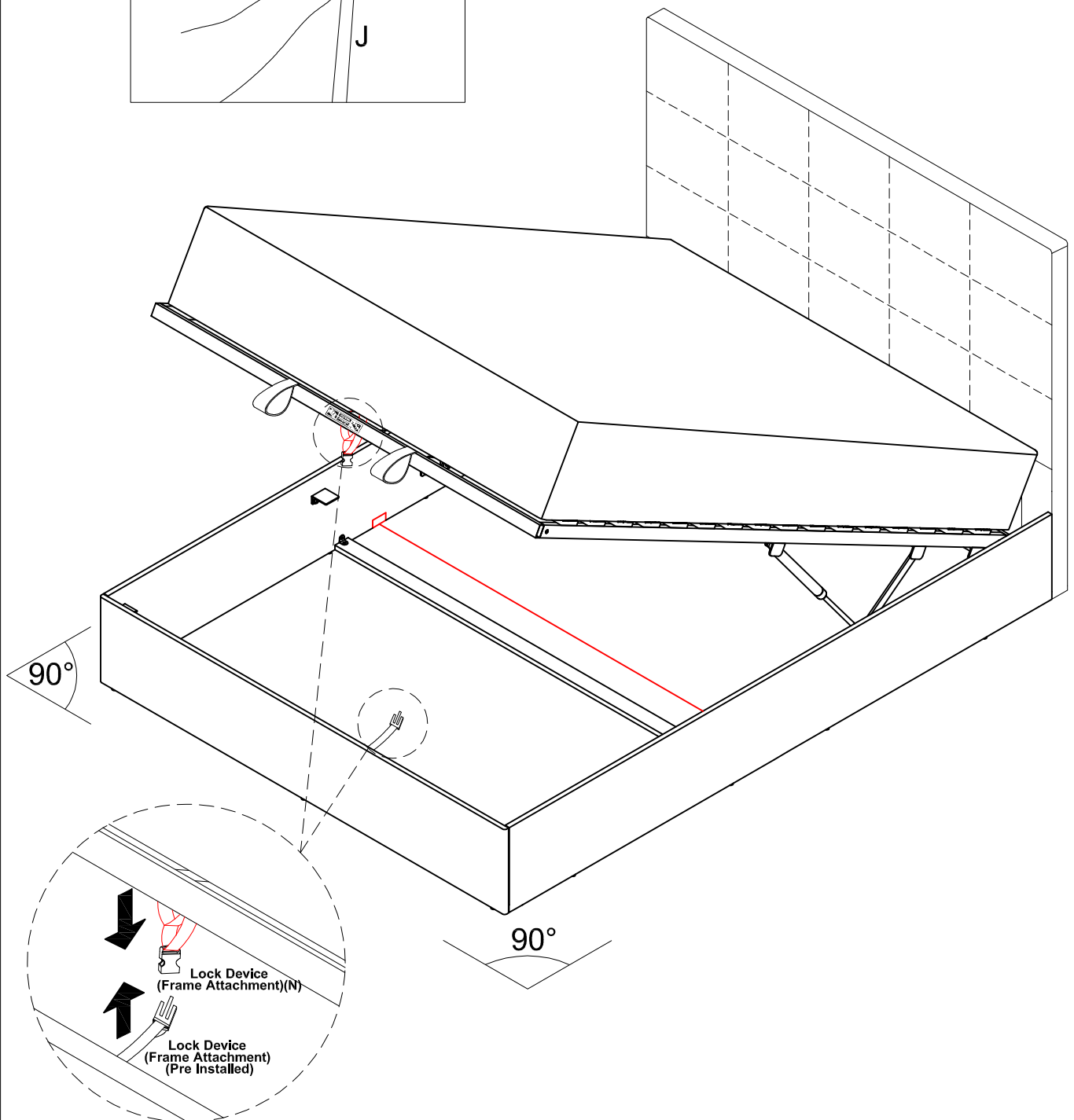
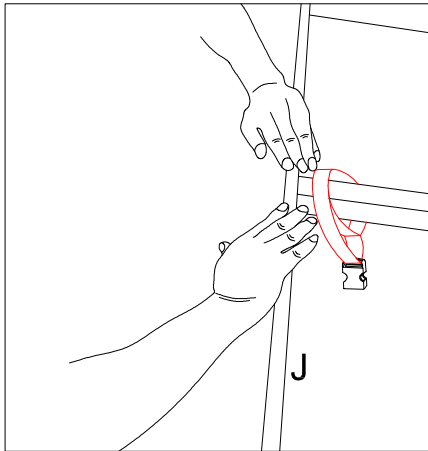

IMPORTANT NOTICE

- Always use both handles to lift the metal base.
- Always use both hands to lower down the metal base
- **The mattress must be fitted to the metal base in order for it to close.**
- **Do not operate the Lift Up Mechanism without the mattress fitted to the metal base**

Caution : Please be aware, if the mattress is removed the lift up base may open on its own.

"IMPORTANT NOTICE"

- WARNING: PLEASE DO NOT ALLOW CHILDREN OR PETS INSIDE THE STORAGE AREA.
- WARNING: PLEASE BE CAREFUL WHEN LIFTING. ONLY LIFT WITH MATTRESS ON TOP. TO BE OPERATED BY ADULTS ONLY.
- WARNING: PLEASE DO NOT PRESS DOWN ON THE MATTRESS WHEN THE BED FRAME IS IN THE LIFT UP POSITION.
- WARNING: THE BED FRAME TOP MUST BE ONLY CLOSED BY USING BOTH HANDS.

PLEASE READ THE FOLLOWING INSTRUCTIONS.

1. KEEP AWAY FROM DIRECT SUNLIGHT TO AVOID DISCOLORATION.
2. DO NOT DRAG THE BED ACROSS THE FLOOR WHEN POSITIONING OR MOVING WHILST CLEANING.
3. WIPE CLEAN WITH A DAMP CLOTH.
4. TIGHTEN ALL SCREW AT REGULAR INTERVALS, TO AVOID DAMAGE TO THE FRAME.
5. ENJOY YOUR PRODUCT.

